



















WRENCHES

- p. 394  --- Ratchets wrenches
- p. 395  --- Double open end wrenches
- p. 396  --- Combination spanners
- p. 398  --- Ring spanners
- p. 401  --- Tubular sockets
- p. 403  --- Hex keys
- p. 405  --- Tork keys
- p. 407  --- T-handle swivel
- p. 408  --- Filter wrenches
- p. 409  --- Torque wrenches







SOCKET WRENCHES AND SCREW EXTRACTORS

- p. 412  --- Quick-release ratchets
- p. 414  --- Sockets
- p. 428  --- Impact sockets
- p. 436  --- Screw extractors









SCREWDRIVERS AND HAND RIVETERS

- p. 437  --- Sockets screwdrivers
- p. 439  --- Screwdrivers
- p. 443  --- Precision screwdrivers
- p. 445  --- Hex bits
- p. 450  --- Hand riveters



PLIERS, HAMMERS, FILES AND CHISELS

- p. 452  --- Pliers
- p. 456  --- Grip pliers
- p. 457  --- Pipe wrenches
- p. 458  --- Hammers
- p. 461  --- Chisels
- p. 464  --- Files
- p. 466  --- Levers





UTILITY KNIVES, DEBURRING AND CUTTING TOOLS

- p. 467  --- Utility knives
- p. 469  --- Snaggers
- p. 471  --- Jigsaws arches
- p. 472  --- Scissors
- p. 473  --- Tube and bolt cutters





SETS AND FASTENINGS

- p. 476  --- Staplers and brad nailers
- p. 476  --- Sets



CONSTRUCTION AND PACKAGING

- p. 481  --- Guns for chemicals
- p. 482  --- Trowels and putty knives
- p. 483  --- Packaging material



TOOL KITS

- p. 484  --- Tool rolling cabinets with tools
- p. 490  --- Series of tools in trays
- p. 499  --- Tool boxes with tools



0690-

RATCHET FLEXIBLE HEAD COMBINATION SPANNER



Hangable
 Cr-V
 Chromed
 3113
 72 teeth



Art.	Size	Length
0690/08	8 mm	150 mm
0690/09	9 mm	150 mm
0690/10	10 mm	160 mm
0690/11	11 mm	170 mm
0690/12	12 mm	170 mm
0690/13	13 mm	185 mm
0690/14	14 mm	205 mm
0690/15	15 mm	205 mm
0690/16	16 mm	230 mm
0690/17	17 mm	230 mm
0690/18	18 mm	250 mm
0690/19	19 mm	250 mm

0690/07P

RATCHET FLEXIBLE HEAD COMBINATION SPANNER SET



7 Pcs
 Hangable
 Cr-V
 Chromed
 3113



Sizes 8 - 10 - 11 - 13 - 15 - 17 - 19 mm

0690/12P

RATCHET FLEXIBLE HEAD COMBINATION SPANNER SET



12 Pcs
 Hangable
 Cr-V
 Chromed
 3113



Sizes 8 - 9 - 10 - 11 - 12 - 13 - 14 - 15 - 16 - 17 - 18 - 19 mm

0700-

RATCHET GEAR WRENCHES



Hangable
 Cr-V
 Chromed
 72 teeth

Art.	Size	Length
0700/08	8 mm	140 mm
0700/09	9 mm	150 mm
0700/10	10 mm	160 mm
0700/11	11 mm	165 mm
0700/12	12 mm	172 mm
0700/13	13 mm	180 mm
0700/14	14 mm	190 mm
0700/15	15 mm	220 mm
0700/16	16 mm	221 mm
0700/17	17 mm	225 mm
0700/18	18 mm	238 mm
0700/19	19 mm	248 mm

0700/07P

RATCHET COMBINATION SPANNER SET

7 Pcs
 Hangable
 Cr-V
 Chromed
 72 teeth



Sizes 8 - 10 - 11 - 13 - 15 - 17 - 19 mm

0700/12P

RATCHET COMBINATION SPANNER SET

12 Pcs
 Hangable
 Cr-V
 Chromed
 72 teeth



Sizes 8 - 9 - 10 - 11 - 12 - 13 - 14 - 15 - 16 - 17 - 18 - 19 mm



0546

SATIN FINISH COMBINATION SPANNER SET



Sizes 6 - 7 - 8 - 9 - 10 - 11 - 12 - 13 - 14 - 17 - 19 - 22 mm

0544

COMBINATION SPANNER SET



Sizes 6-7-8-9-10-11-12-13-14-15-16-17-18-19-20-21-22-23-24-25-26-27-28-30-32 mm

0201-

DOUBLE OPEN END MIRROR POLISH LONG PATTERN WRENCH



Art.	Size	Length
0201/06X07	6x7 mm	122 mm
0201/08X09	8x9 mm	140 mm
0201/10X11	10x11 mm	156 mm
0201/12X13	12x13 mm	172 mm
0201/14X15	14x15 mm	190 mm
0201/16X17	16x17 mm	190 mm
0201/18X19	18x19 mm	225 mm
0201/20X22	20x22 mm	235 mm
0201/21X23	21x23 mm	250 mm
0201/24X27	24x27 mm	265 mm

Art.	Size	Length
0201/25X28	25x28 mm	280 mm
0201/30X32	30x32 mm	300 mm
0201/32X36	32x36 mm	325 mm
0201/34X36	34x36 mm	325 mm
0201/35X38	35x38 mm	330 mm
0201/36X41	36x41 mm	360 mm
0201/41X46	41x46 mm	400 mm
0201/46X50	46x50 mm	450 mm
0201/50X55	50x55 mm	485 mm
0201/55X60	55x60 mm	520 mm

0200

DOUBLE OPEN END MIRROR POLISH LONG PATTERN WRENCH SET



Sizes 6x7 - 8x9 - 10x11 - 12x13 - 14x15 - 16x17 - 18x19 - 20x22 mm

0201

DOUBLE OPEN END MIRROR POLISH LONG PATTERN WRENCH SET



Sizes 6x7 - 8x9 - 10x11 - 12x13 - 14x15 - 16x17 - 18x19 - 20x22 - 21x23 - 24x27 - 25x28 - 30x32 mm



**0208-
MIRROR POLISH LONG PATTERN COMBINATION SPANNER**



Cr-V
Chromed 3113

Art.	Size	Length
0208/06	6 mm	100 mm
0208/07	7 mm	110 mm
0208/08	8 mm	120 mm
0208/09	9 mm	130 mm
0208/10	10 mm	140 mm
0208/11	11 mm	150 mm
0208/12	12 mm	160 mm
0208/13	13 mm	170 mm
0208/14	14 mm	180 mm
0208/15	15 mm	190 mm
0208/16	16 mm	200 mm
0208/17	17 mm	210 mm
0208/18	18 mm	220 mm
0208/19	19 mm	230 mm
0208/20	20 mm	240 mm
0208/21	21 mm	250 mm
0208/22	22 mm	260 mm
0208/23	23 mm	270 mm
0208/24	24 mm	280 mm
0208/25	25 mm	290 mm
0208/26	26 mm	300 mm
0208/27	27 mm	310 mm
0208/28	28 mm	320 mm
0208/30	30 mm	340 mm
0208/32	32 mm	360 mm
0208/34	34 mm	380 mm
0208/36	36 mm	400 mm
0208/38	38 mm	400 mm
0208/41	41 mm	440 mm
0208/46	46 mm	490 mm
0208/50	50 mm	530 mm

**0199
MIRROR POLISH LONG PATTERN COMBINATION SPANNER SET**



Cr-V
Chromed 3113

Sizes 6 - 7 - 8 - 9 - 10 - 11 - 12 - 13 - 14 - 17 - 19 - 22 mm

**0208
MIRROR POLISH LONG PATTERN COMBINATION SPANNER SET**



Cr-V
Chromed 3113

Sizes 6-7-8-9-10-11-12-13-14-15-16-17-18-19-20-21-22-23-24-25-26-27-28-30-32 mm

**0204
MIRROR POLISH LONG PATTERN COMBINATION SPANNER SET**



Cr-V
Chromed 3113

Sizes 34 - 36 - 38 - 41 - 46 - 50 mm

**0199P-
MIRROR POLISH LONG PATTERN COMBINATION SPANNER**

Inches.



Cr-V
Chromed 3113

Art.	Size	Length
0199P/1/4	1/4"	100 mm
0199P/5/16	5/16"	120 mm
0199P/3/8	3/8"	140 mm
0199P/7/16	7/16"	150 mm
0199P/1/2	1/2"	170 mm
0199P/9/16	9/16"	180 mm
0199P/5/8	5/8"	200 mm
0199P/11/16	11/16"	210 mm
0199P/3/4	3/4"	230 mm
0199P/13/16	13/16"	250 mm
0199P/7/8	7/8"	260 mm
0199P/15/16	15/16"	280 mm
0199P/1	1"	290 mm

**0199P
MIRROR POLISH LONG PATTERN COMBINATION SPANNER SET**

Inches.



Cr-V
Chromed 3113

Size 1/4" - 5/16" - 3/8" - 7/16" - 1/2" - 9/16" - 5/8" - 11/16" - 3/4" - 13/16" - 7/8" - 15/16" - 1"



0222-

DOUBLE OPEN END WRENCH



Cr-V

Satin 3110

Art.	Size	Length
0222/06X07	6x7 mm	122 mm
0222/08X09	8x9 mm	140 mm
0222/10X11	10x11 mm	155 mm
0222/12X13	12x13 mm	170 mm
0222/14X15	14x15 mm	190 mm
0222/16X17	16x17 mm	205 mm
0222/18X19	18x19 mm	220 mm
0222/20X22	20x22 mm	235 mm
0222/21X23	21x23 mm	250 mm
0222/24X27	24x27 mm	265 mm
0222/25X28	25x28 mm	280 mm
0222/30X32	30x32 mm	300 mm

0224-

COMBINATION SPANNER



Cr-V

Satin 3113

Art.	Size	Length
0224/06	6 mm	100 mm
0224/07	7 mm	110 mm
0224/08	8 mm	120 mm
0224/09	9 mm	130 mm
0224/10	10 mm	140 mm
0224/11	11 mm	150 mm
0224/12	12 mm	160 mm
0224/13	13 mm	170 mm
0224/14	14 mm	180 mm
0224/15	15 mm	190 mm
0224/16	16 mm	200 mm
0224/17	17 mm	210 mm
0224/18	18 mm	220 mm
0224/19	19 mm	230 mm
0224/20	20 mm	240 mm
0224/21	21 mm	250 mm
0224/22	22 mm	260 mm
0224/23	23 mm	270 mm
0224/24	24 mm	280 mm
0224/25	25 mm	290 mm
0224/26	26 mm	300 mm
0224/27	27 mm	310 mm
0224/28	28 mm	320 mm
0224/30	30 mm	340 mm
0224/32	32 mm	360 mm
0224/34	34 mm	380 mm
0224/36	36 mm	400 mm

0221

DOUBLE OPEN END WRENCH SET



8 Pcs Hangable

Cr-V

Chromed 3110

Sizes 6x7 - 8x9 - 10x11 - 12x13 - 14x15 - 16x17 - 18x19 - 20x22 mm

0222

DOUBLE OPEN END WRENCH SET



12 Pcs Hangable

Cr-V

Chromed 3110

Sizes 6x7 - 8x9 - 10x11 - 12x13 - 14x15 - 16x17 - 18x19 - 20x22 - 21x23 - 24x27 - 25x28 - 30x32 mm

0073

COMBINATION SPANNER



12 Pcs Hangable

Cr-V

Chromed 3113

Sizes 6 - 7 - 8 - 9 - 10 - 11 - 12 - 13 - 14 - 17 - 19 - 22 mm

0223

COMBINATION SPANNER

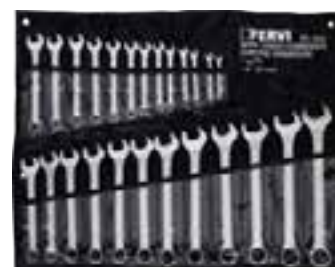

25 Pcs Box

Cr-V

Chromed 3113

Sizes 6-7-8-9-10-11-12-13-14-15-16-17-18-19-20-21-22-23-24-25-26-27-28-30-32 mm



0476-

MIRROR POLISH RING SPANNERS

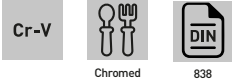

Art.	Size	Length
0476/06X07	6 x 7 mm	165 mm
0476/08X09	8 x 9 mm	180 mm
0476/10X11	10 x 11 mm	195 mm
0476/12X13	12 x 13 mm	215 mm
0476/14X15	14 x 15 mm	240 mm
0476/16X17	16 x 17 mm	260 mm
0476/18X19	18 x 19 mm	320 mm
0476/20X22	20 x 22 mm	320 mm
0476/21X23	21 x 23 mm	325 mm
0476/24X27	24 x 27 mm	335 mm
0476/25X28	25 x 28 mm	345 mm
0476/30X32	30 x 32 mm	360 mm

0477

MIRROR POLISH RING SPANNER SET



Sizes 6x7 - 8x9 - 10x11 - 12x13 - 14x15 - 16x17 - 18x19 - 20x22 mm

0476

MIRROR POLISH RING SPANNER SET

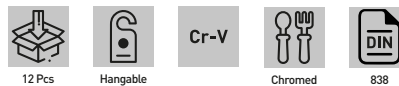

Sizes 6x7 - 8x9 - 10x11 - 12x13 - 14x15 - 16x17 - 18x19 - 20x22 - 21x23 - 24x27 - 25x28 - 30x32 mm

0895-

PERCUSSION OPEN WRENCHES

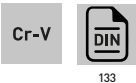

Art.	Size	Length
0895/24	24 mm	160 mm
0895/27	27 mm	180 mm
0895/30	30 mm	195 mm
0895/32	32 mm	195 mm
0895/36	36 mm	215 mm
0895/38	38 mm	215 mm
0895/41	41 mm	235 mm
0895/46	46 mm	255 mm
0895/50	50 mm	280 mm
0895/55	55 mm	310 mm
0895/60	60 mm	320 mm
0895/65	65 mm	345 mm
0895/70	70 mm	370 mm

0896-

POLYGONAL PERCUSSION WRENCHES



Art.	Size	Length
0896/24	24 mm	160 mm
0896/27	27 mm	180 mm
0896/30	30 mm	195 mm
0896/32	32 mm	195 mm
0896/36	36 mm	205 mm
0896/38	38 mm	215 mm
0896/41	41 mm	230 mm
0896/46	46 mm	240 mm
0896/50	50 mm	255 mm
0896/55	55 mm	270 mm
0896/60	60 mm	280 mm
0896/65	65 mm	300 mm
0896/70	70 mm	325 mm



0196-

STUBBY MIRROR POLISH COMBINATION SPANNERS

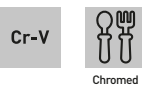

Art.	Size	Length
0196/10	10 mm	95 mm
0196/11	11 mm	105 mm
0196/12	12 mm	105 mm
0196/13	13 mm	110 mm
0196/14	14 mm	115 mm
0196/15	15 mm	115 mm
0196/16	16 mm	125 mm
0196/17	17 mm	130 mm
0196/18	18 mm	140 mm
0196/19	19 mm	140 mm

0134-

FLAT POLYGONAL WRENCHES



Art.	Size	Length
0134/06X07	6 x 7 mm	100 mm
0134/08X09	8 x 9 mm	115 mm
0134/10X11	10 x 11 mm	130 mm
0134/12X13	12 x 13 mm	145 mm
0134/14X15	14 x 15 mm	160 mm
0134/16X17	16 x 17 mm	170 mm
0134/18X19	18 x 19 mm	185 mm
0134/20X22	20 x 22 mm	205 mm

0196

STUBBY MIRROR POLISH COMBINATION SPANNER SET



Sizes 10-11-12-13-14-15-16-17-18-19 mm

0134S

FLAT RING SPANNER SET

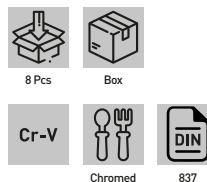

Sizes 100 - 6x7 mm, 115 - 8x9 mm, 130 - 10x11 mm, 145 - 12x13 mm, 160 - 14x15 mm, 170 - 16x17 mm, 185 - 18x19 mm, 205 - 20x20 mm

0187

MULTILOCK COMBINATION SPANNER SET

Suitable for metric, inch, torx and XZN bolt.

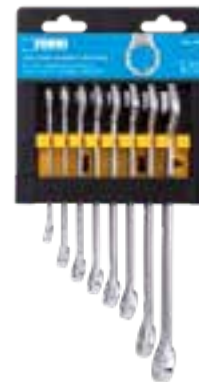

Sizes 8 - 10 - 11 - 12 - 13 - 14 - 17 - 19 mm
 Inch size 5/16" - 3/8" - 7/16" - 15/32" - 1/2" - 9/16" - 11/16" - 3/4"
 Torx size E10 - E12 - E14 - E16 - E18 - E22 - E24
 XZN size M8 - M10 - M11 - M12 - M13 - M14 - M17 - M19

0541S

FLARE NUT WRENCH SET

6 point from 8 mm to 14 mm, 12 point from 17 mm to 22 mm.

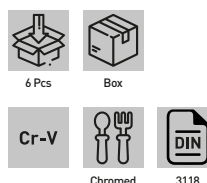

Sizes 140-8x10 mm, 150-9x11 mm, 175-11x13 mm, 175-12x14 mm, 210-17x19 mm, 220-19x22 mm



0614-

HALF MOON RING SPANNERS

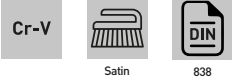

Art.	Size
0614/08X10	8 x 10 mm
0614/10X12	10 x 12 mm
0614/11X13	11 x 13 mm
0614/13X15	13 x 15 mm
0614/14X17	14 x 17 mm
0614/16X18	16 x 18 mm
0614/19X22	19 x 22 mm

0084-

ADJUSTABLE WRENCHES

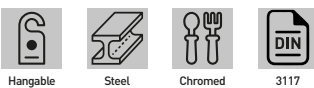

Art.	Size	Opening
0084/150	6"-150 mm	20 mm
0084/250	10"- 250 mm	30 mm
0084/375	15"- 375 mm	48 mm



0614

SET OF HALF MOON RING SPANNERS



Sizes 8x10 - 10x12 - 11x13 - 13x15 - 14x17 - 16x18 - 19x22 mm

0714

HOOK WRENCHES SET

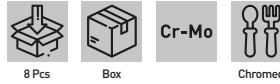

Model 35 + 120
 Sizes 35+60 60+90 90+120

0266

GAS SPANNER

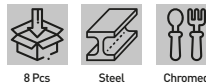

Size 25 mm
 Pack 10

0340S

DOUBLE HEAD SOCKET WRENCH SET

Ideal for loosen and tighten nuts and bolts located in positions hard to get



Sizes 8x9-10x11-12x13-14x15-16x17-18x19 mm



0393-
DOUBLE ENDED HEXAGON/BI-HEX SOCKET WRENCHES



Art.	Size	Length
0393/06	6 mm	100 mm
0393/07	7 mm	105 mm
0393/08	8 mm	115 mm
0393/09	9 mm	120 mm
0393/10	10 mm	130 mm
0393/11	11 mm	135 mm
0393/12	12 mm	145 mm
0393/13	13 mm	150 mm
0393/14	14 mm	160 mm
0393/15	15 mm	170 mm
0393/16	16 mm	180 mm
0393/17	17 mm	185 mm
0393/18	18 mm	200 mm
0393/19	19 mm	200 mm
0393/20	20 mm	210 mm
0393/21	21 mm	220 mm
0393/22	22 mm	230 mm

0442-
HEXAGONAL TUBULAR SOCKET WRENCHES
Mirror polish with hexagonal body.

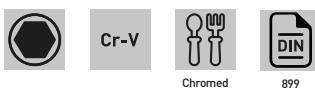

Art.	Size	Length
0442/06X07	6 x 7 mm	105 mm
0442/08X09	8 x 9 mm	110 mm
0442/10X11	10 x 11 mm	120 mm
0442/12X13	12 x 13 mm	140 mm
0442/14X15	14 x 15 mm	145 mm
0442/16X17	16 x 17 mm	155 mm
0442/18X19	18 x 19 mm	165 mm
0442/20X22	20 x 22 mm	170 mm

0393/A
DOUBLE ENDED HEXAGON/BI-HEX SOCKET WRENCHES SET



Sizes 6-7-8-10-11-12-13-14-17-19

0393
DOUBLE ENDED HEXAGON/BI-HEX SOCKET WRENCHES



Sizes 6 - 7 - 8 - 10 - 11 - 12 - 13 - 14 - 17 - 19 - 22 mm

0442
HEXAGONAL TUBULAR SOCKET WRENCH SET
Mirror polish with hexagonal body.

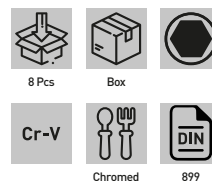

Sizes 105 - 6x7 mm, 110 - 8x9 mm, 120 - 10x11 mm, 140 - 12x13 mm, 145 - 14x15 mm, 155 - 16x17 mm, 165 - 18x19 mm, 170 - 20x22 mm



0540-

HEXAGONAL TUBULAR SOCKET WRENCH

Light model



Steel

Satin

Art.	Size	Length
0540/06X07	6 x 7 mm	110 mm
0540/08X09	8 x 9 mm	120 mm
0540/10X11	10 x 11 mm	125 mm
0540/12X13	12 x 13 mm	135 mm
0540/14X15	14 x 15 mm	135 mm
0540/16X17	16 x 17 mm	150 mm
0540/18X19	18 x 19 mm	160 mm
0540/20X22	20 x 22 mm	170 mm

0540S

HEXAGONAL TUBULAR SOCKET WRENCH SET

Light model, with tommy bar.



8 Pcs

Box



Steel

Chromed



Sizes 6x7 8x9 10x11 12x13 14x15 16x17 18x19 20x22 mm

0540/3

TOMMY BAR

3 step.



Steel

Chromed



Length 165 mm
 ø 9,5 - 7,5 - 6 mm





0090- MALE HEX KEY SET

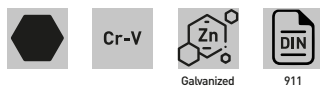

Art.	L1	L2	Pack
0090/015	45 mm	14 mm	10
0090/02	50 mm	16 mm	10
0090/025	56 mm	18 mm	10
0090/03	63 mm	20 mm	10
0090/04	70 mm	25 mm	10
0090/05	80 mm	28 mm	10
0090/06	90 mm	32 mm	10
0090/08	100 mm	36 mm	5
0090/10	112 mm	40 mm	5
0090/12	125 mm	45 mm	5
0090/14	140 mm	56 mm	5
0090/17	160 mm	63 mm	5
0090/19	180 mm	70 mm	5

0558/GE HEX KEY SET

With ph and slot screwdriver head, with multipurpose handle that can be used as a t-handle or as a key extension.



Sizes	2 - 2,5 - 3 - 4 - 5 - 6 - 8 - 10 mm
Cross screwdriver	PH0 (3 mm) - PH1 (4 mm) - PH2 (5 mm)
Slotted screwdriver	6 mm

0215X BALL POINT HEX KEY SET , LONG TYPE



Art.	Size
0215	1,5 - 2 - 2,5 - 3 - 4 - 5 - 6 - 8 - 10
0215P	1/16" - 5/64" - 3/32" - 1/8" - 5/32" - 3/16" - 1/4" - 5/16" - 3/8"

0090 HEX KEY SET



Sizes	1,5 - 2 - 2,5 - 3 - 3,5 - 4 - 5 - 6 - 8 - 10 mm
-------	---

0269 HEX KEY SET



Sizes	1,5 - 2 - 2,5 - 3 - 4 - 5 - 6 - 8 - 10 mm
-------	---

0545/EF BALL POINT COLORED HEX KEY SERIES



Sizes	1,5 - 2 - 2,5 - 3 - 4 - 5 - 6 - 8 - 10 mm
-------	---



0558/EM

HEX KEY SET WITH DIAMOND TIP

The diamond tip allows a perfect grip, avoiding to ruin the head of the screw. This type of tip is also very effective with already ruined screws.

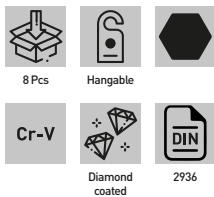

Sizes 1,5 - 2 - 2,5 - 3 - 4 - 5 - 6 - 8 mm

0558/EP

HEX KEY SET WITH DIAMOND TIP

The diamond tip allows a perfect grip, avoiding to ruin the head of the screw. This type of tip is also very effective with already ruined screws.

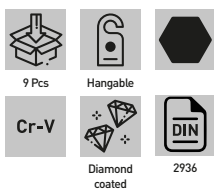

Sizes 5/64" - 3/32" - 7/64" - 1/8" - 9/64" - 5/32" - 3/16" - 7/32" - 1/4"

0856-

BALL POINT TWO WAY HEX KEY WITH ANATOMIC PLASTIC HANDLE

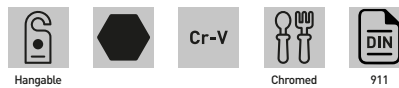

Art.	Size	Length
0856/02	2 mm	100 mm
0856/02.5	2,5 mm	100 mm
0856/03	3 mm	100 mm
0856/04	4 mm	100 mm
0856/05	5 mm	150 mm
0856/06	6 mm	150 mm
0856/08	8 mm	200 mm
0856/10	10 mm	200 mm

C856-

BALL POINT TWO WAY HEX KEY WITH PLASTIC HANDLE



Art.	Size	Length
C856/02.5	2.5 mm	175 mm
C856/03	3 mm	175 mm
C856/04	4 mm	175 mm
C856/05	5 mm	175 mm
C856/06	6 mm	175 mm
C856/08	8 mm	170 mm
C856/10	10 mm	170 mm

0400-

MALE "T" HANDLE HEX WRENCHES

With sliding bar making it versatile for use in difficult situations and under extreme conditions.

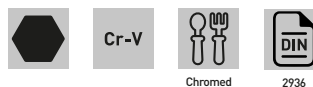

Art.	Size	Dimensions
0400/02	2 mm	125 x 65 mm
0400/025	2,5 mm	125 x 65 mm
0400/03	3 mm	125 x 65 mm
0400/035	3,5 mm	125 x 65 mm
0400/04	4 mm	180 x 90 mm
0400/045	4,5 mm	180 x 90 mm
0400/05	5 mm	180 x 90 mm
0400/06	6 mm	210 x 105 mm
0400/07	7 mm	250 x 105 mm
0400/08	8 mm	250 x 125 mm
0400/09	9 mm	300 x 145 mm
0400/10	10 mm	300 x 145 mm
0400/12	12 mm	320 x 165 mm
0400/14	14 mm	340 x 170 mm



0400

MALE "T" HANDLE HEX WRENCH SET

With sliding bar making them versatile for use in difficult situations and under extreme conditions.

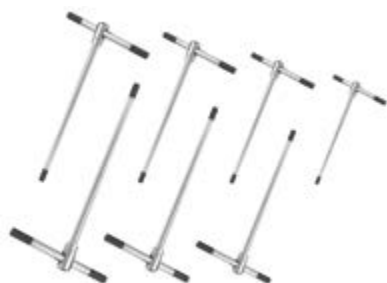
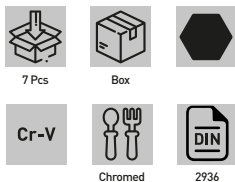

Sizes 2 - 3 - 4 - 5 - 6 - 8 - 10 mm

0190

3-WAY SPEEDY HEX KEY WRENCH SET

With practical "speedy" rotating handle for increased working velocity.



Sizes 2 - 3 - 4 - 5 - 6 - 8 - 10 mm

0220

TORX KEY SET LONG TYPE

With tamper resistant head (hole).

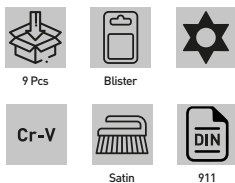

Sizes T10 - T15 - T20 - T25 - T27 - T30 - T40 - T45 - T50

0220/C

TORX KEY SET SHORT TYPE

With tamper resistant head (hole).



Sizes T10 - T15 - T20 - T25 - T27 - T30 - T40 - T45 - T50

0545/TF

COLORED TORX KEY SERIES

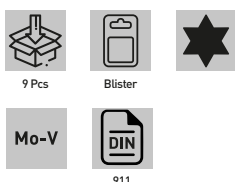

Sizes T10 - T15 - T20 - T25 - T27 - T30 - T40 - T45 - T50

0558/TX

TORX KEY SET WITH DIAMOND TIP

DIN ISO 2936, the diamond tip allows a perfect grip, avoiding to ruin the head of the screw. This type of tip is also very effective with already ruined screws.

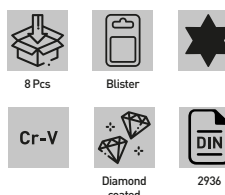

Sizes T9 - T10 - T15 - T20 - T25 - T27 - T30 - T40



0855-

TWO WAY TORX AND TAMPERED KEY WITH ANATOMIC PLASTIC HANDLE



Art.	Size	Length
0855/T10	T10	100 mm
0855/T15	T15	100 mm
0855/T20	T20	100 mm
0855/T25	T25	100 mm
0855/T30	T30	150 mm
0855/T40	T40	150 mm

C855-

TWO WAY TORX KEY WITH PLASTIC HANDLE

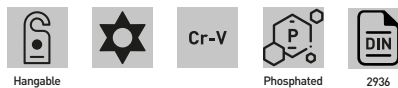

Art.	Size	Length
C855/T10	T10	175 mm
C855/T15	T15	175 mm
C855/T20	T20	175 mm
C855/T25	T25	175 mm
C855/T27	T27	175 mm
C855/T30	T30	175 mm
C855/T40	T40	170 mm
C855/T50	T50	170 mm

0405-

MALE "T" HANDLE TORX WRENCH

With sliding bar making it versatile for use in difficult situations and under extreme conditions.

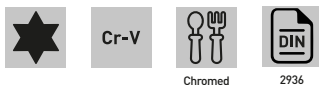

Art.	Size	Length
0405/T06	T06	125 mm
0405/T07	T07	125 mm
0405/T08	T08	125 mm
0405/T09	T09	125 mm
0405/T10	T10	125 mm
0405/T15	T15	125 mm
0405/T20	T20	125 mm
0405/T25	T25	180 mm
0405/T27	T27	180 mm
0405/T30	T30	180 mm
0405/T40	T40	210 mm
0405/T45	T45	210 mm
0405/T50	T50	210 mm

0405

MALE "T" HANDLE TORX WRENCH SET

With sliding bar making them versatile for use in difficult situations and under extreme conditions.



Sizes T8-T9-T10-T15-T20-T25-T30

0190T

NEW

3-WAY "SPEEDY" TORX KEY WRENCH SET

Torx keys made of brushed aluminium and high-strength Cr-V steel, perfect for torx socket screws. Practical "speedy" swivel handle for a firmer grip and greater ease and quick handling. Sizes from T10 to T40.



Sizes T10 - T15 - T20 - T25 - T27 - T30 - T40



0359-

T-HANDLE SPARK PLUG SOCKET WRENCH



Art.	Size	Length
0359/14L	14 mm	530 mm
0359/16L	16 mm	530 mm
0359/21L	20,8 mm	530 mm
0359/16	16 mm	275 mm

007X

SPARK PLUG WRENCH

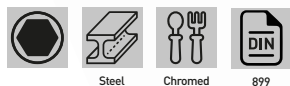

Art.	Size	Length
0078	20,8	500 mm
0079	16 mm	510 mm

C395-

T HANDLE MAGNETIC SWIVEL HEX SOCKET

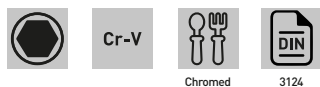

Art.	Size	Length
C395/06	6 mm	390 mm
C395/07	7 mm	390 mm
C395/08	8 mm	390 mm
C395/09	9 mm	390 mm
C395/10	10 mm	500 mm
C395/11	11 mm	500 mm
C395/12	12 mm	500 mm
C395/13	13 mm	500 mm
C395/14	14 mm	500 mm
C395/15	15 mm	500 mm
C395/16	16 mm	500 mm
C395/17	17 mm	500 mm
C395/18	18 mm	500 mm
C395/19	19 mm	500 mm

C245-

T-HANDLE DEEP SOCKET WRENCHES

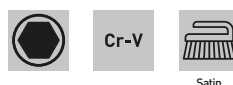

Art.	Size	Length
C245/06	6 mm	320 mm
C245/07	7 mm	320 mm
C245/08	8 mm	320 mm
C245/09	9 mm	320 mm
C245/10	10 mm	320 mm
C245/11	11 mm	320 mm
C245/12	12 mm	320 mm
C245/13	13 mm	320 mm
C245/14	14 mm	320 mm
C245/17	17 mm	320 mm
C245/19	19 mm	320 mm

C391-

T-HANDLE SWIVEL HEX SOCKET

Heavy duty.

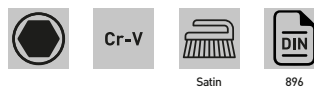

Art.	Size	Length
C391/06	6 mm	395 mm
C391/07	7 mm	395 mm
C391/08	8 mm	395 mm
C391/09	9 mm	400 mm
C391/10	10 mm	400 mm
C391/11	11 mm	400 mm
C391/12	12 mm	400 mm
C391/13	13 mm	432 mm
C391/14	14 mm	432 mm
C391/15	15 mm	450 mm
C391/16	16 mm	450 mm
C391/17	17 mm	450 mm
C391/18	18 mm	450 mm
C391/19	19 mm	500 mm



0352-

BELT OIL FILTER WRENCH



Art.	Filter maximum diameter	Belt
0352/01	180 mm	610 mm
0352/02	220 mm	800 mm

0357-

OIL FILTER STEEL BELT WRENCH

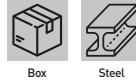

Art.	Filter maximum diameter	Belt
0357/01	70 mm	180 mm
0357/02	120 mm	200 mm

0076

TAPE OIL FILTER WRENCH

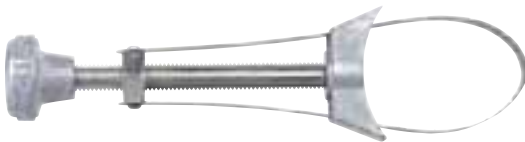

Filter maximum diameter	Belt
120 mm	195 mm

0077

OIL FILTER CHAIN WRENCH



Filter maximum diameter	Belt
110 mm	380 mm

0018/15

OIL FILTER WRENCH SET

Useful for the removal of oil filters for many vehicles. An adapter with 3/8" male and 1/2" female drives is included in the set.



Sizes (ø mm - sides)
65 mm - 14, 65/67 mm - 14, 68 mm - 14, 74 mm - 15, 74/76 mm - 15, 75/77 mm - 15, 76 mm - 14, 76 mm - 30, 80 mm - 15, 80/82 mm
Adapter drive
1/2" (F) 3/8" (M)

0018/30

OIL FILTER WRENCH SET

Useful for the removal of oil filters for many vehicles. An adapter with 3/8" male and 1/2" female drives and a 3-jaw wrench are included in the set.



Sizes (ø mm - sides)
65 mm - 14, 65/67 mm - 14, 66 mm - 6, 68 mm - 14, 73 mm - 14, 74 mm - 15, 74/76 mm - 15, 75/77 mm - 15, 76 mm - 8, 76 mm - 12, 76 mm - 14, 76 mm - 30, 78 mm - 15, 80 mm - 15, 80/82 mm - 15, 86 mm - 16, 86 mm - 18, 90 mm - 15, 92 mm - 10, 93 mm - 15, 93 mm - 36, 93 mm
Adapter drive
1/2" (F) 3/8" (M)
3 - Jaw wrench
65 ÷ 120 mm



0080

CROSS RIM WRENCH



Sizes	17 - 19 - 21 mm
Dimensions	381 x 16 mm

0426-

CROSS RIM WRENCH

For trucks, with fixed hex sockets.

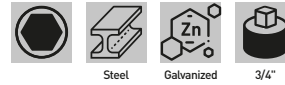

Art.	Sizes	Dimensions
0426/30	24 - 27 - 30 mm	550 x 20 mm
0426/32	24 - 27 - 32 mm	700 x 22 mm

0806/200

ELECTRONIC DIGITAL TORQUE - ANGLE WRENCH

It allows cw and ccw operation and a led and buzer diagnostic of torque/angle status.

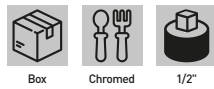

MEASURE UNITS:	Nm / kgf-cm / lbf-ft / lbf-in	Angle accuracy	±1%
Capacity	20 ÷ 200 Nm	Operation mode	Peak / Track
Reading	0,1 Nm	Torque memories - Angle	5
Accuracy	±2%, 10% @ 200 Nm	Length	605 mm
Angle range	0 ÷ 360°	Battery	4x 1,5 V AAA

0809-

ELECTRONIC DIGITAL TORQUE WRENCH

It allows cw and ccw operation and a led and buzer diagnostic of torque status.



Art.	MEASURE UNITS:	Capacity	Reading	Accuracy	Operation mode	Memory	Dr.	Length	Battery
0809/030	Nm / kgf-cm / lbf-ft / lbf-in	6 ÷ 30 Nm	0,01 Nm	±4%	Peak / Track	50	1/4"	200 mm	2 x 3 V CR2032
0809/080	Nm / kgf-m / lbf-ft / lbf-in	16 ÷ 80 Nm	0,1 Nm	±3%	Peak / Track	50	3/8"	230 mm	2 x 3 V CR2032
0809/100	Nm / kgf-m / lbf-ft / lbf-in	20 ÷ 100 Nm	0,1 Nm	±2%	Peak / Track	50	1/2"	275 mm	2 x 3 V CR2032

0806/020
DIGITAL TORQUE SCREWDRIVER

ISO 6789-2017, clockwise and anticlockwise tightening, sound and vibration diagnostics of the preset torque reached.



MEASURE UNITS:	Nm / lbft / lbin
Capacity	0 ÷ 20 Nm
Reading	0,01 Nm
Accuracy	±2%
Operation mode	Peak / Track
Auto power off	5 min.
Length	175 mm
Battery	2 x 1,5 V AAA
Working temperature	0 °C - 40 °C
Storage temperature	-5 °C - 45 °C

0268A
DIGITAL TORQUE METER

Twist monitoring tool. Applied to a ratchet wrench it can be used as a torque wrench. Backlit LCD screen, Peak and Trace operating mode. Auto power off function.

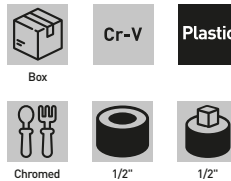

Operation mode	Peak/track
MEASURE UNITS:	Nm/kgm/kgcm/lbft/lbin
Capacity	40 ÷ 200 Nm
Reading	0,1 Nm
Memory	50
Accuracy	±2%
Dimensions	75 x 44 mm
Battery	2 x AAA
Working temperature	-10°C-60 °C [-14°F-139.9 °F]
Storage temperature	-20°C -70°C [-4 °F-157.9°F]

0137
TORQUE WRENCH

Capacity	28 ÷ 210 Nm
Extension	120 mm

0815-
TORQUE WRENCHES

ISO 6789-2017, reading window.



Art.	Dr.	Capacity	Reading	Accuracy	Length
0815/100	3/8"	20 ÷ 100 Nm	0,5 Nm	±4%	460 mm
0815/200	1/2"	40 ÷ 200 Nm	1,0 Nm	±4%	515 mm
0815/800	3/4"	100 ÷ 800 Nm	5,0 Nm	±4%	1100 mm



0803-

TORQUE WRENCHES

ISO 6789-2017.



Art.	Shank	Capacity	Reading	Accuracy	Length
0803/110	3/8"	20 - 110 Nm	0,5 Nm	±4%	380 mm
0803/210	1/2"	40 - 210 Nm	1 Nm	±4%	535 mm
0803/700	3/4"	140 - 700 Nm	2,5 Nm	±4%	1085 mm

0803/S210

TORQUE WRENCH SET

ISO 6789-2017.

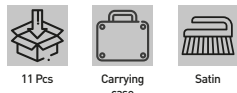

Spanners shank	14 x 18 mm
Ratchet head	1/2"
Capacity	40 ÷ 210 Nm
Accuracy	±4%
Reading	1 Nm
Spanner head	13 - 14 - 15 - 17 - 19 - 22 - 24 - 27 - 30 mm

0803/S080

TORQUE WRENCH SET

ISO 6789-2017.

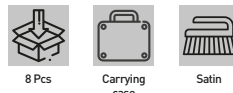

Spanners shank	14x 18 mm
Ratchet head	3/8"
Capacity	15 ÷ 80 Nm
Accuracy	±4%
Spanner head	17 - 22 - 24 - 26 - 27 - 30 mm
Reading	0,5 Nm

0329

TORQUE MULTIPLIER

Labor saving wheel wrench.

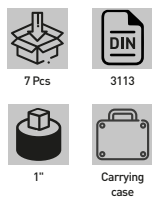

1" Dr. sockets	32 - 33 mm
Ratio	1:60
Maximum torque	3200 Nm
Operating torque	1200 Nm
Net weight	7,5 kg

0360

TORQUE MULTIPLIER

Labor saving wheel wrench, supplied in plastic case.

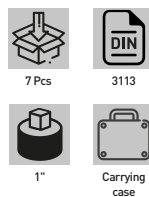

1" Dr. sockets	32 - 33 mm
Ratio	1 : 56
Maximum torque	3000 Nm
Operating torque	1000 Nm
Net weight	7 kg

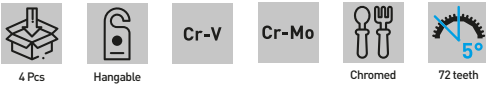
CN450N0/0
3 IN 1 QUICK CHANGE DRIVE RATCHET HANDLE

Length	230 mm
Shank	1/2" - 3/8" - 1/4"
Teeth	72

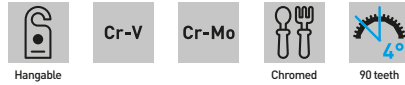
G090-
ERGONOMIC RATCHET HANDLE

Art.	Length	Dr.
G090/1/4	145 mm	1/4"
G090/3/8	195 mm	3/8"
G090/1/2	265 mm	1/2"

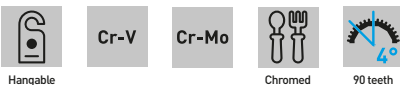
F090-
ERGONOMIC RATCHET HANDLE

Art.	Length	Dr.
F090/1/4	145 mm	1/4"
F090/3/8	195 mm	3/8"
F090/1/2	265 mm	1/2"

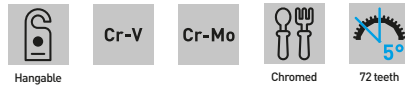
0494-
MIRROR POLISHED ERGONOMIC RATCHET HANDLE

Art.	Length	Dr.
0494/1/4	165 mm	1/4"
0494/3/8	215 mm	3/8"
0494/1/2	276 mm	1/2"

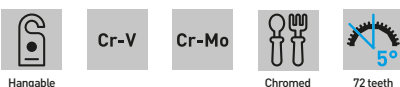
CN450NX
ERGONOMIC RATCHET HANDLE

Art.	Length	Dr.
CN450N1/4A	150 mm	1/4"
CN450N3/8A	205 mm	3/8"
CN450N1/2A	250 mm	1/2"

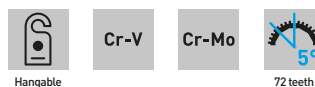
0439-
ERGONOMIC RATCHET HANDLE

Art.	Dr.	Length	Teeth
0439/1/4	1/4"	155 mm	72
0439/3/8	3/8"	200 mm	72
0439/1/2	1/2"	260 mm	72



0019-

1/4", 3/8", 1/2" DRIVE QUICK-RELEASE RATCHETS



Hangable

Cr-V

Cr-Mo



90 teeth

Art.	Length	Dr.
0019/1/4	154 mm	1/4"
0019/3/8	215 mm	3/8"
0019/1/2	275 mm	1/2"

0308

RATCHET HANDLE



Cr-V



Chromed



45 teeth



3/4"

Length	490 mm
--------	--------

0228

RATCHET HANDLE



Hangable

Cr-V



Chromed



39 teeth



1/2"

Length	220 mm
--------	--------

0173

1/4" DR. SPINNER HANDLE

Made to being used also as an extension.



Hangable

Cr-V



Chromed



1/4"



1/4"

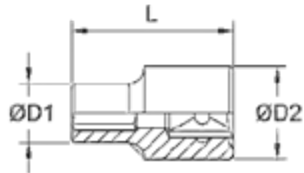

BN4E5NX
STANDARD 6 POINT HAND SOCKET

Art.	Size	D1	D2	Length
BN4E5N004A	4 mm	6,8 mm	12 mm	25 mm
BN4E5N0045A	4,5 mm	7,2 mm	12 mm	25 mm
BN4E5N005A	5 mm	7,8 mm	12 mm	25 mm
BN4E5N0055A	5,5 mm	8,4 mm	12 mm	25 mm
BN4E5N006A	6 mm	9,3 mm	12 mm	25 mm
BN4E5N007A	7 mm	10,8 mm	12 mm	25 mm
BN4E5N008A	8 mm	12 mm	11 mm	25 mm
BN4E5N009A	9 mm	13 mm	12 mm	25 mm
BN4E5N010A	10 mm	14,6 mm	12 mm	25 mm
BN4E5N011A	11 mm	16 mm	12,5 mm	25 mm
BN4E5N012A	12 mm	17 mm	13,5 mm	25 mm
BN4E5N013A	13 mm	18 mm	13,5 mm	25 mm
BN4E5N014A	14 mm	19 mm	14,5 mm	25 mm

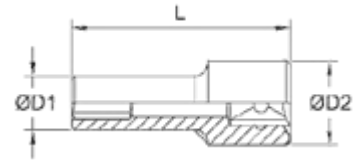
BN4E5LX
DEEP 6 POINT HAND SOCKET

Art.	Size	D1	D2	Length
BN4E5L004A	4 mm	6,8 mm	12 mm	50 mm
BN4E5L0045A	4,5 mm	7,2 mm	12 mm	50 mm
BN4E5L005A	5 mm	7,8 mm	12 mm	50 mm
BN4E5L0055A	5,5 mm	8,4 mm	12 mm	50 mm
BN4E5L006A	6 mm	9,3 mm	12 mm	50 mm
BN4E5L007A	7 mm	10,8 mm	12 mm	50 mm
BN4E5L008A	8 mm	12 mm	11 mm	50 mm
BN4E5L009A	9 mm	13 mm	12 mm	50 mm
BN4E5L010A	10 mm	14,6 mm	12 mm	50 mm
BN4E5L011A	11 mm	16 mm	13 mm	50 mm
BN4E5L012A	12 mm	17 mm	13 mm	50 mm
BN4E5L013A	13 mm	18 mm	13 mm	50 mm
BN4E5L014A	14 mm	19 mm	14,5 mm	50 mm

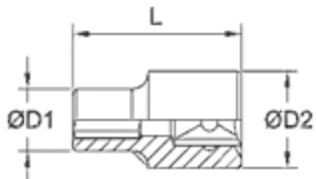
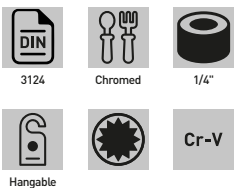
BN4P5NX
STANDARD 12 POINT HAND SOCKET

Art.	Size	D1	D2	Length
BN4P5N004A	4 mm	6,8 mm	12 mm	25 mm
BN4P5N005A	5 mm	7,8 mm	12 mm	25 mm
BN4P5N0055A	5,5 mm	8,4 mm	12 mm	25 mm
BN4P5N006A	6 mm	9,3 mm	12 mm	25 mm
BN4P5N007A	7 mm	10,8 mm	12 mm	25 mm
BN4P5N008A	8 mm	12 mm	11 mm	25 mm
BN4P5N009A	9 mm	13 mm	12 mm	25 mm
BN4P5N010A	10 mm	14,6 mm	12 mm	25 mm
BN4P5N011A	11 mm	16 mm	12,5 mm	25 mm
BN4P5N012A	12 mm	17 mm	13,5 mm	25 mm
BN4P5N013A	13 mm	18 mm	13,5 mm	25 mm
BN4P5N014A	14 mm	19 mm	14,5 mm	25 mm

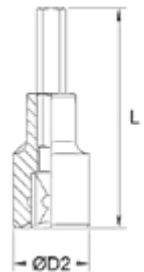
BN415NX
HEX BIT SOCKET

Art.	Size	D2	Length
BN415N003A	3 mm	12 mm	37 mm
BN415N004A	4 mm	12 mm	37 mm
BN415N005A	5 mm	12 mm	37 mm
BN415N006A	6 mm	12 mm	37 mm
BN415N008A	8 mm	12 mm	37 mm



BN425NX

TORX BIT SOCKET

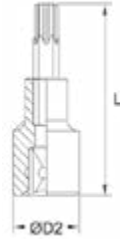

Hangable



Chromed

1/4"

Art.	Size	D2	Length
BN425N008A	T8	12 mm	37 mm
BN425N009A	T9	12 mm	37 mm
BN425N010A	T10	12 mm	37 mm
BN425N015A	T15	12 mm	37 mm
BN425N020A	T20	12 mm	37 mm
BN425N025A	T25	12 mm	37 mm
BN425N027A	T27	12 mm	37 mm
BN425N030A	T30	12 mm	37 mm
BN425N040A	T40	12 mm	37 mm

BN445NX

XZN BIT SOCKET

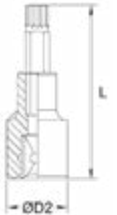

Hangable



Chromed

1/4"

Art.	Size	D2	Length
BN445N004A	M 4	15 mm	37 mm
BN445N005A	M 5	15 mm	37 mm
BN445N006A	M 6	15 mm	37 mm
BN445N008A	M 8	15 mm	37 mm
BN445N009A	M 9	15 mm	37 mm
BN445N010A	M 10	15 mm	37 mm

RN4054NA

ADAPTER



Hangable



1/4"

3/8"



Length 26 mm

JN405NA

UNIVERSAL JOINT



Hangable



1/4"



Length 38 mm

PN405NX

EXTENSION BAR



Hangable



Chromed

1/4"

Art.	Length
PN405N050A	50 mm
PN405N075A	75 mm
PN405N150A	150 mm

EN405NX

WOBBLE EXTENSION BAR



Hangable



Chromed

1/4"

Art.	Length
EN405N050A	50 mm
EN405N075A	75 mm
EN405N150A	150 mm

LN400N1/4A

SLIDING T BAR



Hangable



Cr-V

1/4"

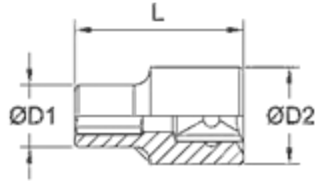

Length 115 mm

BN4E4NX
STANDARD 6 POINT HAND SOCKET

Art.	Size	D1	D2	Length
BN4E4N006A	6 mm	9,3 mm	17 mm	28 mm
BN4E4N007A	7 mm	10,6 mm	17 mm	28 mm
BN4E4N008A	8 mm	11,8 mm	17 mm	28 mm
BN4E4N009A	9 mm	13,2 mm	17 mm	28 mm
BN4E4N010A	10 mm	14,5 mm	17 mm	28 mm
BN4E4N011A	11 mm	15,7 mm	17 mm	28 mm
BN4E4N012A	12 mm	17 mm	16,4 mm	28 mm
BN4E4N013A	13 mm	18 mm	17 mm	28 mm
BN4E4N014A	14 mm	20 mm	17 mm	28 mm
BN4E4N015A	15 mm	20,9 mm	18 mm	28 mm
BN4E4N016A	16 mm	22 mm	18 mm	28 mm
BN4E4N017A	17 mm	24 mm	18 mm	30 mm
BN4E4N018A	18 mm	26 mm	18 mm	30 mm
BN4E4N019A	19 mm	26 mm	20 mm	30 mm
BN4E4N020A	20 mm	27,1 mm	20 mm	30 mm
BN4E4N021A	21 mm	28 mm	20 mm	30 mm
BN4E4N022A	22 mm	30 mm	20 mm	32 mm

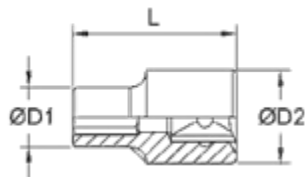
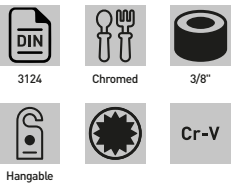
BN4P4NX
STANDARD 12 POINT HAND SOCKET

Art.	Size	D1	D2	Length
BN4P4N006A	6 mm	9,3 mm	17 mm	28 mm
BN4P4N007A	7 mm	10,6 mm	17 mm	28 mm
BN4P4N008A	8 mm	11,8 mm	17 mm	28 mm
BN4P4N009A	9 mm	13,2 mm	17 mm	28 mm
BN4P4N010A	10 mm	14,5 mm	17 mm	28 mm
BN4P4N011A	11 mm	15,7 mm	17 mm	28 mm
BN4P4N012A	12 mm	17 mm	16,4 mm	28 mm
BN4P4N013A	13 mm	18 mm	17 mm	28 mm
BN4P4N014A	14 mm	20 mm	17 mm	28 mm
BN4P4N015A	15 mm	20,9 mm	18 mm	28 mm
BN4P4N016A	16 mm	22 mm	18 mm	28 mm
BN4P4N017A	17 mm	24 mm	18 mm	30 mm
BN4P4N018A	18 mm	26 mm	18 mm	30 mm
BN4P4N019A	19 mm	26 mm	20 mm	30 mm
BN4P4N020A	20 mm	28 mm	20 mm	30 mm
BN4P4N021A	21 mm	28 mm	20 mm	30 mm
BN4P4N022A	22 mm	30 mm	20 mm	32 mm

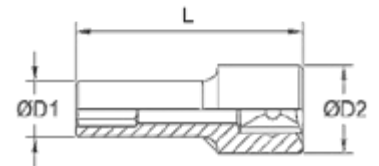
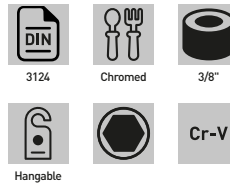
BN4E4LX
DEEP 6 POINT HAND SOCKET

Art.	Size	D1	D2	Length
BN4E4L006A	6 mm	9,3 mm	17 mm	63 mm
BN4E4L007A	7 mm	10,6 mm	17 mm	62 mm
BN4E4L008A	8 mm	11,8 mm	17 mm	63 mm
BN4E4L009A	9 mm	13,2 mm	17 mm	63 mm
BN4E4L010A	10 mm	14,5 mm	17 mm	63 mm
BN4E4L011A	11 mm	15,7 mm	17 mm	63 mm
BN4E4L012A	12 mm	17 mm	16,4 mm	63 mm
BN4E4L013A	13 mm	18 mm	17 mm	63 mm
BN4E4L014A	14 mm	19,6 mm	17 mm	63 mm
BN4E4L015A	15 mm	20,9 mm	18 mm	63 mm
BN4E4L016A	16 mm	22 mm	18 mm	63 mm
BN4E4L017A	17 mm	23,4 mm	18 mm	63 mm
BN4E4L018A	18 mm	24,6 mm	20 mm	63 mm
BN4E4L019A	19 mm	26 mm	20 mm	63 mm
BN4E4L020A	20 mm	27,1 mm	20 mm	63 mm
BN4E4L021A	21 mm	28 mm	20 mm	63 mm
BN4E4L022A	22 mm	30 mm	20 mm	63 mm





BN414NX

HEX BIT SOCKET

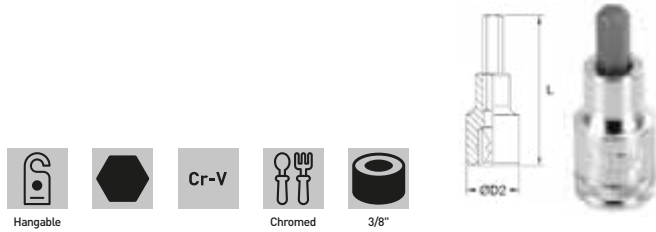

Art.	Size	D2	Length
BN414N003A	3 mm	18 mm	48 mm
BN414N004A	4 mm	18 mm	48 mm
BN414N005A	5 mm	18 mm	48 mm
BN414N006A	6 mm	18 mm	48 mm
BN414N007A	7 mm	18 mm	48 mm
BN414N008A	8 mm	18 mm	48 mm
BN414N009A	9 mm	20 mm	48 mm
BN414N010A	10 mm	20 mm	48 mm
BN414N012A	12 mm	20 mm	48 mm

BN414LX

LONG HEX BIT SOCKET

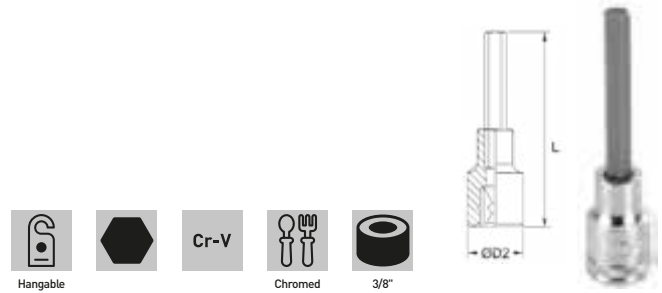

Art.	Size	D2	Length
BN414L003A	3 mm	18 mm	95 mm
BN414L004A	4 mm	18 mm	95 mm
BN414L005A	5 mm	18 mm	95 mm
BN414L006A	6 mm	18 mm	95 mm
BN414L007A	7 mm	18 mm	95 mm
BN414L008A	8 mm	18 mm	95 mm
BN414L009A	9 mm	20 mm	95 mm
BN414L010A	10 mm	20 mm	95 mm
BN414L012A	12 mm	20 mm	95 mm

BN424NX

TORX BIT SOCKET

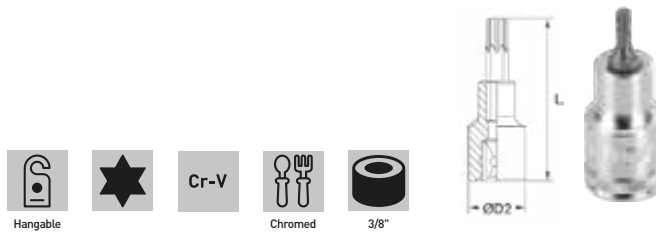

Art.	Size	D2	Length
BN424N010A	T10	18 mm	48 mm
BN424N015A	T15	18 mm	48 mm
BN424N020A	T20	18 mm	48 mm
BN424N025A	T25	18 mm	48 mm
BN424N027A	T27	18 mm	48 mm
BN424N030A	T30	18 mm	48 mm
BN424N040A	T40	18 mm	48 mm
BN424N045A	T45	18 mm	48 mm
BN424N050A	T50	20 mm	48 mm
BN424N055A	T55	20 mm	48 mm

BN424LX

LONG TORX BIT SOCKET

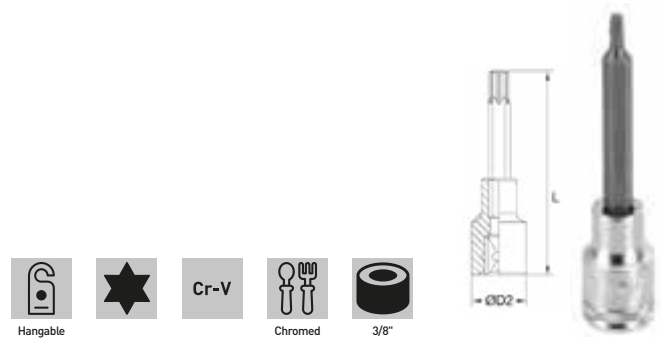

Art.	Size	D2	Length
BN424L015A	T15	18 mm	95 mm
BN424L020A	T20	18 mm	95 mm
BN424L025A	T25	18 mm	95 mm
BN424L027A	T27	18 mm	95 mm
BN424L030A	T30	18 mm	95 mm
BN424L040A	T40	18 mm	95 mm
BN424L045A	T45	18 mm	95 mm

BN434NX

RIBE BIT SOCKET

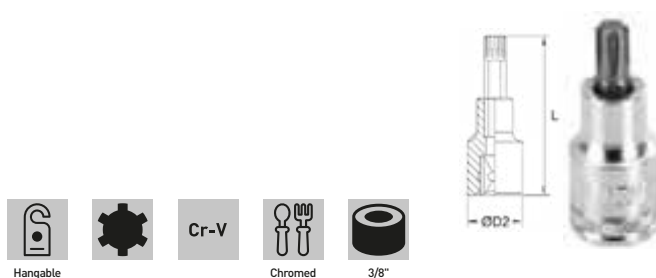

Art.	Size	D2	Length
BN434N004A	M 4	18 mm	50 mm
BN434N005A	M 5	18 mm	50 mm
BN434N006A	M 6	18 mm	50 mm
BN434N007A	M 7	18 mm	50 mm
BN434N008A	M 8	18 mm	50 mm
BN434N009A	M 9	18 mm	50 mm
BN434N010A	M 10	20 mm	50 mm

BN434LX

LONG RIBE BIT SOCKET

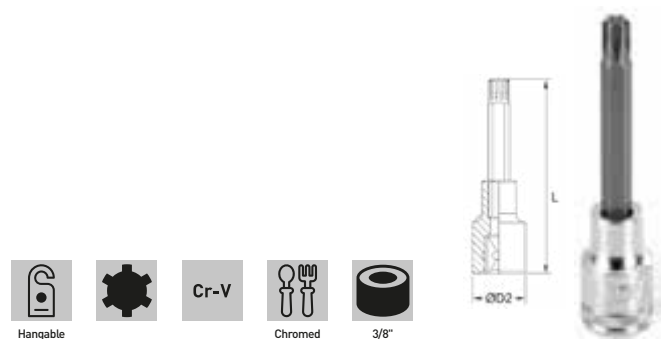

Art.	Size	D2	Length
BN434L004A	M 4	18 mm	95 mm
BN434L005A	M 5	18 mm	95 mm
BN434L006A	M 6	18 mm	95 mm
BN434L007A	M 7	18 mm	95 mm
BN434L008A	M 8	18 mm	95 mm
BN434L009A	M 9	18 mm	95 mm
BN434L010A	M 10	20 mm	95 mm

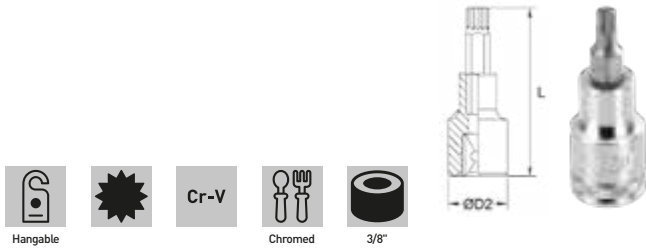
BN444NX
XZN BIT SOCKET

Art.	Size	D2	Length
BN444N004A	M 4	18 mm	48 mm
BN444N005A	M 5	18 mm	48 mm
BN444N006A	M 6	18 mm	48 mm
BN444N008A	M 8	18 mm	48 mm
BN444N009A	M 9	20 mm	48 mm
BN444N010A	M 10	20 mm	48 mm
BN444N012A	M 12	20 mm	48 mm
BN444N014A	M 14	20 mm	48 mm

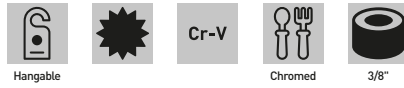
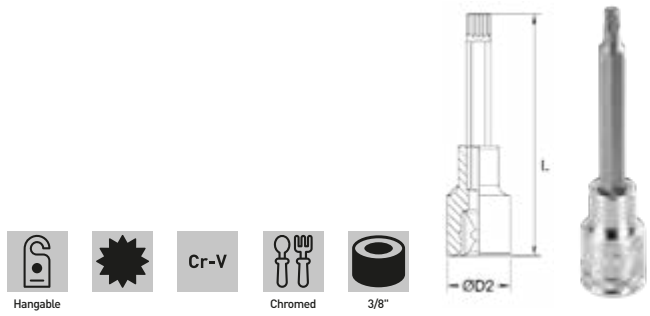
BN444LX
LONG XZN BIT SOCKET

Art.	Size	D2	Length
BN444L004A	M 4	18 mm	95 mm
BN444L005A	M 5	18 mm	95 mm
BN444L006A	M 6	18 mm	95 mm
BN444L008A	M 8	18 mm	95 mm
BN444L009A	M 9	20 mm	95 mm
BN444L010A	M 10	20 mm	95 mm
BN444L012A	M 12	20 mm	95 mm
BN444L014A	M 14	20 mm	95 mm

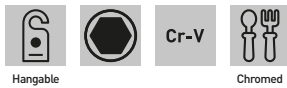
BN4C4LX
SPARK PLUG SOCKET

Art.	Size	Length
BN4C4L016A	16 mm	63 mm
BN4C4L018A	18 mm	63 mm
BN4C4L021A	21 mm	65 mm

LN400N3/8A
SLIDING T BAR

Length 200 mm

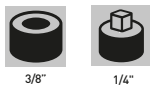
RN4045NA
ADAPTER

Length 27 mm

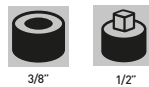
RN4043NA
ADAPTER

Length 35 mm

JN404NA
UNIVERSAL JOINT

Length 54 mm

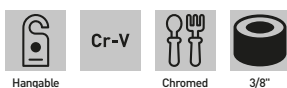
PN404NX
EXTENSION BAR

Art.	Length
PN404N050A	50 mm
PN404N075A	75 mm
PN404N150A	150 mm

EN404NX
WOBBLE EXTENSION BAR

Art.	Length
EN404N038A	38 mm
EN404N075A	75 mm
EN404N150A	150 mm
EN404N250A	250 mm





BN4E3NX

STANDARD 6 POINT HAND SOCKET



Art.	Size	D1	D2	Length
BN4E3N008A	8 mm	12,2 mm	22 mm	38 mm
BN4E3N009A	9 mm	13,5 mm	22 mm	38 mm
BN4E3N010A	10 mm	15 mm	22 mm	38 mm
BN4E3N011A	11 mm	16,3 mm	22 mm	38 mm
BN4E3N012A	12 mm	17,6 mm	22 mm	38 mm
BN4E3N013A	13 mm	18,8 mm	22 mm	38 mm
BN4E3N014A	14 mm	20,4 mm	22 mm	38 mm
BN4E3N015A	15 mm	21 mm	22 mm	38 mm
BN4E3N016A	16 mm	22 mm	20,5 mm	38 mm
BN4E3N017A	17 mm	24 mm	22 mm	38 mm
BN4E3N018A	18 mm	25,4 mm	22 mm	38 mm
BN4E3N019A	19 mm	26 mm	22 mm	38 mm
BN4E3N020A	20 mm	28 mm	22 mm	38 mm
BN4E3N021A	21 mm	28 mm	22 mm	38 mm
BN4E3N022A	22 mm	30 mm	26 mm	38 mm
BN4E3N023A	23 mm	31,6 mm	26 mm	38 mm
BN4E3N024A	24 mm	32 mm	26 mm	38 mm
BN4E3N025A	25 mm	34 mm	26 mm	42 mm
BN4E3N026A	26 mm	35,4 mm	28 mm	42 mm
BN4E3N027A	27 mm	36 mm	28 mm	42 mm
BN4E3N028A	28 mm	38 mm	28 mm	42 mm
BN4E3N029A	29 mm	38 mm	28 mm	43 mm
BN4E3N030A	30 mm	40 mm	28 mm	43 mm
BN4E3N032A	32 mm	42 mm	28 mm	44 mm

BN4E3LX

DEEP 6 POINT HAND SOCKET

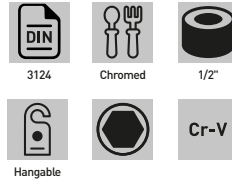

Art.	Size	D1	D2	Length
BN4E3L010A	10 mm	15 mm	22 mm	77 mm
BN4E3L011A	11 mm	16,3 mm	22 mm	77 mm
BN4E3L012A	12 mm	17,6 mm	22 mm	77 mm
BN4E3L013A	13 mm	18,8 mm	22 mm	77 mm
BN4E3L014A	14 mm	20,4 mm	22 mm	77 mm
BN4E3L015A	15 mm	21 mm	22 mm	77 mm
BN4E3L016A	16 mm	22 mm	20,5 mm	77 mm
BN4E3L017A	17 mm	24 mm	22 mm	77 mm
BN4E3L018A	18 mm	25,4 mm	22 mm	77 mm
BN4E3L019A	19 mm	26 mm	22 mm	77 mm
BN4E3L020A	20 mm	28 mm	22 mm	77 mm
BN4E3L021A	21 mm	28 mm	22 mm	77 mm
BN4E3L022A	22 mm	30 mm	26 mm	77 mm
BN4E3L023A	23 mm	31,6 mm	26 mm	77 mm
BN4E3L024A	24 mm	32 mm	26 mm	77 mm
BN4E3L027A	27 mm	36 mm	28 mm	77 mm
BN4E3L030A	30 mm	40 mm	28 mm	77 mm
BN4E3L032A	32 mm	42 mm	28 mm	77 mm

BN4P3NX

STANDARD 12 POINT HAND SOCKET



Art.	Size	D1	D2	Length
BN4P3N008A	8 mm	12,2 mm	22 mm	38 mm
BN4P3N009A	9 mm	13,5 mm	22 mm	38 mm
BN4P3N010A	10 mm	15 mm	22 mm	38 mm
BN4P3N011A	11 mm	16,3 mm	22 mm	38 mm
BN4P3N012A	12 mm	17,6 mm	22 mm	38 mm
BN4P3N013A	13 mm	18,8 mm	22 mm	38 mm
BN4P3N014A	14 mm	20,4 mm	22 mm	38 mm
BN4P3N015A	15 mm	21 mm	22 mm	38 mm
BN4P3N016A	16 mm	22 mm	20,5 mm	38 mm
BN4P3N017A	17 mm	24 mm	22 mm	38 mm
BN4P3N018A	18 mm	25,4 mm	22 mm	38 mm
BN4P3N019A	19 mm	26 mm	22 mm	38 mm
BN4P3N020A	20 mm	28 mm	22 mm	38 mm
BN4P3N021A	21 mm	28 mm	22 mm	38 mm
BN4P3N022A	22 mm	30 mm	26 mm	38 mm
BN4P3N023A	23 mm	31,6 mm	26 mm	38 mm
BN4P3N024A	24 mm	32 mm	26 mm	38 mm
BN4P3N025A	25 mm	34 mm	26 mm	42 mm
BN4P3N026A	26 mm	35,4 mm	28 mm	42 mm
BN4P3N027A	27 mm	36 mm	28 mm	42 mm
BN4P3N028A	28 mm	38 mm	28 mm	43 mm
BN4P3N029A	29 mm	38 mm	28 mm	43 mm
BN4P3N030A	30 mm	40 mm	28 mm	43 mm
BN4P3N032A	32 mm	42 mm	28 mm	44 mm

BN4P3LX

DEEP 12 POINT HAND SOCKET

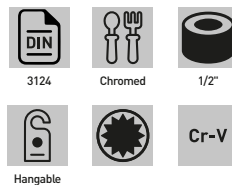

Art.	Size	D1	D2	Length
BN4P3L010A	10 mm	15 mm	22 mm	77 mm
BN4P3L011A	11 mm	16,3 mm	22 mm	77 mm
BN4P3L012A	12 mm	17,6 mm	22 mm	77 mm
BN4P3L013A	13 mm	18,8 mm	22 mm	77 mm
BN4P3L014A	14 mm	20,4 mm	22 mm	77 mm
BN4P3L015A	15 mm	21 mm	22 mm	77 mm
BN4P3L016A	16 mm	22 mm	20,5 mm	77 mm
BN4P3L017A	17 mm	24 mm	22 mm	77 mm
BN4P3L018A	18 mm	25,4 mm	22 mm	77 mm
BN4P3L019A	19 mm	26 mm	22 mm	77 mm
BN4P3L020A	20 mm	28 mm	22 mm	77 mm
BN4P3L021A	21 mm	28 mm	22 mm	77 mm
BN4P3L022A	22 mm	30 mm	26 mm	77 mm
BN4P3L023A	23 mm	31,6 mm	26 mm	77 mm
BN4P3L024A	24 mm	32 mm	26 mm	77 mm
BN4P3L027A	27 mm	36 mm	28 mm	77 mm
BN4P3L030A	30 mm	40 mm	28 mm	77 mm
BN4P3L032A	32 mm	42 mm	28 mm	77 mm

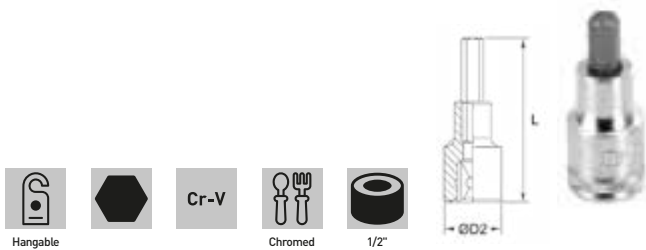
BN413NX
HEX BIT SOCKET

Art.	Size	D2	Length
BN413N004A	4 mm	22 mm	55 mm
BN413N005A	5 mm	22 mm	55 mm
BN413N006A	6 mm	22 mm	55 mm
BN413N007A	7 mm	22 mm	55 mm
BN413N008A	8 mm	22 mm	55 mm
BN413N010A	10 mm	22 mm	55 mm
BN413N012A	12 mm	22 mm	55 mm
BN413N014A	14 mm	24 mm	55 mm
BN413N017A	17 mm	26 mm	55 mm
BN413N019A	19 mm	28 mm	55 mm

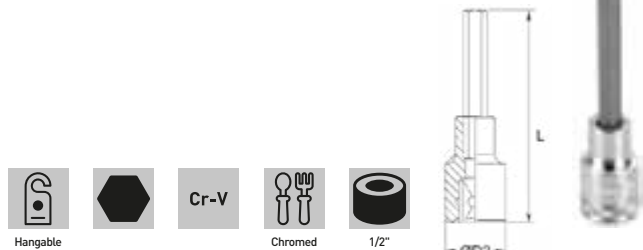
BN413LX
LONG HEX BIT SOCKET

Art.	Size	D2	Length
BN413L004A	4 mm	22 mm	100 mm
BN413L005A	5 mm	22 mm	100 mm
BN413L006A	6 mm	22 mm	100 mm
BN413L007A	7 mm	22 mm	100 mm
BN413L008A	8 mm	22 mm	100 mm
BN413L010A	10 mm	22 mm	100 mm
BN413L012A	12 mm	22 mm	100 mm
BN413L014A	14 mm	24 mm	100 mm
BN413L017A	17 mm	26 mm	100 mm
BN413L019A	19 mm	28 mm	100 mm

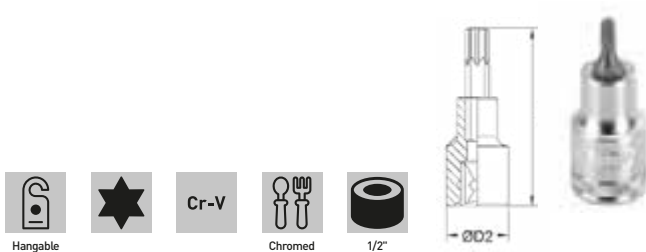
BN423NX
TORX BIT SOCKET

Art.	Size	D2	Length
BN423N020A	T20	22 mm	55 mm
BN423N025A	T25	22 mm	55 mm
BN423N027A	T27	22 mm	55 mm
BN423N030A	T30	22 mm	55 mm
BN423N040A	T40	22 mm	55 mm
BN423N045A	T45	22 mm	55 mm
BN423N050A	T50	22 mm	55 mm
BN423N055A	T55	22 mm	55 mm
BN423N060A	T60	22 mm	55 mm
BN423N070A	T70	22 mm	55 mm

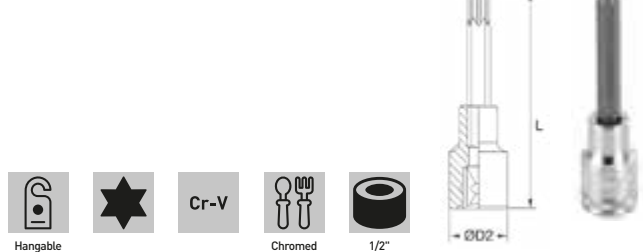
BN423LX
LONG TORX BIT SOCKET

Art.	Size	D2	Length
BN423L020A	T20	22 mm	100 mm
BN423L025A	T25	22 mm	100 mm
BN423L027A	T27	22 mm	100 mm
BN423L030A	T30	22 mm	100 mm
BN423L040A	T40	22 mm	100 mm
BN423L045A	T45	22 mm	100 mm
BN423L050A	T50	22 mm	100 mm
BN423L055A	T55	22 mm	100 mm
BN423L060A	T60	22 mm	100 mm
BN423L070A	T70	22 mm	100 mm

BN433NX
RIBE BIT SOCKET

Art.	Size	D2	Length
BN433N008A	M 8	22 mm	55 mm
BN433N009A	M 9	22 mm	55 mm
BN433N010A	M 10	22 mm	55 mm
BN433N012A	M 12	22 mm	55 mm
BN433N013A	M 13	24 mm	55 mm
BN433N014A	M 14	24 mm	55 mm

BN433LX
LONG RIBE BIT SOCKET

Art.	Size	D2	Length
BN433L008A	M 8	24 mm	100 mm
BN433L009A	M 9	24 mm	100 mm
BN433L010A	M 10	24 mm	100 mm
BN433L012A	M 12	24 mm	100 mm
BN433L013A	M 13	24 mm	100 mm
BN433L014A	M 14	24 mm	100 mm



BN443NX

XZN BIT SOCKET



Art.	Size	D2	Length
BN443N005A	M 5	22 mm	55 mm
BN443N006A	M 6	22 mm	55 mm
BN443N008A	M 8	22 mm	55 mm
BN443N009A	M 9	22 mm	55 mm
BN443N010A	M 10	22 mm	55 mm
BN443N012A	M 12	22 mm	55 mm
BN443N014A	M 14	24 mm	55 mm
BN443N016A	M 16	24 mm	55 mm

BN443LX

LONG XZN BIT SOCKET



Art.	Size	D2	Length
BN443L005A	M 5	22 mm	100 mm
BN443L006A	M 6	22 mm	100 mm
BN443L008A	M 8	22 mm	100 mm
BN443L009A	M 9	22 mm	100 mm
BN443L010A	M 10	22 mm	100 mm
BN443L012A	M 12	22 mm	100 mm
BN443L014A	M 14	24 mm	100 mm
BN443L016A	M 16	24 mm	100 mm

BN4C3LX

SPARK PLUG SOCKET



Art.	Size	Length
BN4C3L016A	16 mm	65 mm
BN4C3L018A	18 mm	65 mm
BN4C3L021A	21 mm	65 mm

PN403NX

EXTENSION BAR



Art.	Length
PN403N050A	50 mm
PN403N075A	75 mm
PN403N150A	150 mm
PN403N250A	250 mm

EN403NX

WOBBLE EXTENSION BAR



Art.	Dr.	Length
EN403N050A	1/2"	50 mm
EN403N075A	1/2"	75 mm
EN403N125A	1/2"	125 mm
EN403N250A	1/2"	250 mm
EN403N500A	1/2"	500 mm

LN400N1/2A

SLIDING T BAR



Length	300 mm
--------	--------

RN4034NA

ADAPTER



Length	36 mm
--------	-------

RN4032NA

ADAPTER



Length	46 mm
--------	-------

JN403NA

UNIVERSAL JOINT

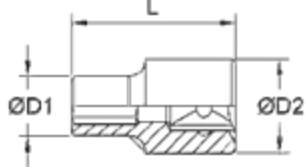

Length	75 mm
--------	-------

BN4E2NX
STANDARD 6 POINT HAND SOCKET

Art.	Size	D1	D2	Length
BN4E2N019	19 mm	30 mm	36 mm	50 mm
BN4E2N020	20 mm	31 mm	36 mm	50 mm
BN4E2N021	21 mm	32 mm	36 mm	50 mm
BN4E2N022	22 mm	33 mm	36 mm	50 mm
BN4E2N023	23 mm	34 mm	36 mm	50 mm
BN4E2N024	24 mm	35 mm	36 mm	50 mm
BN4E2N025	25 mm	36 mm	35 mm	52 mm
BN4E2N026	26 mm	37 mm	36 mm	52 mm
BN4E2N027	27 mm	38 mm	36 mm	52 mm
BN4E2N028	28 mm	39 mm	38 mm	52 mm
BN4E2N029	29 mm	40 mm	38 mm	52 mm
BN4E2N030	30 mm	42 mm	38 mm	54 mm
BN4E2N032	32 mm	43 mm	38 mm	56 mm
BN4E2N033	33 mm	44 mm	38 mm	56 mm
BN4E2N034	34 mm	46 mm	38 mm	56 mm
BN4E2N035	35 mm	47 mm	42 mm	56 mm
BN4E2N036	36 mm	48 mm	42 mm	58 mm
BN4E2N038	38 mm	50 mm	42 mm	58 mm
BN4E2N041	41 mm	52 mm	45 mm	60 mm
BN4E2N046	46 mm	56 mm	45 mm	64 mm
BN4E2N050	50 mm	62 mm	48 mm	68 mm
BN4E2N055	55 mm	68 mm	48 mm	72 mm
BN4E2N060	60 mm	74 mm	48 mm	76 mm

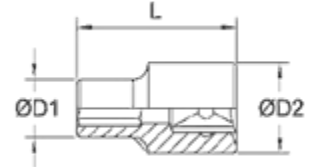
BN4P2NX
STANDARD 12 POINT HAND SOCKET

Art.	Size	D1	D2	Length
BN4P2N019	19 mm	30 mm	36 mm	50 mm
BN4P2N020	20 mm	31 mm	36 mm	50 mm
BN4P2N021	21 mm	32 mm	36 mm	50 mm
BN4P2N022	22 mm	33 mm	36 mm	50 mm
BN4P2N023	23 mm	34 mm	36 mm	50 mm
BN4P2N024	24 mm	35 mm	36 mm	50 mm
BN4P2N025	25 mm	36 mm	35 mm	52 mm
BN4P2N026	26 mm	37 mm	36 mm	52 mm
BN4P2N027	27 mm	38 mm	36 mm	52 mm
BN4P2N028	28 mm	39 mm	38 mm	52 mm
BN4P2N029	29 mm	40 mm	38 mm	52 mm
BN4P2N030	30 mm	42 mm	38 mm	54 mm
BN4P2N032	32 mm	43 mm	38 mm	56 mm
BN4P2N033	33 mm	44 mm	38 mm	56 mm
BN4P2N034	34 mm	46 mm	38 mm	56 mm
BN4P2N035	35 mm	47 mm	42 mm	56 mm
BN4P2N036	36 mm	48 mm	42 mm	58 mm
BN4P2N038	38 mm	50 mm	42 mm	58 mm
BN4P2N041	41 mm	52 mm	45 mm	60 mm
BN4P2N046	46 mm	56 mm	45 mm	64 mm
BN4P2N050	50 mm	62 mm	48 mm	68 mm
BN4P2N055	55 mm	68 mm	48 mm	72 mm
BN4P2N060	60 mm	74 mm	48 mm	76 mm

PN402NX
EXTENSION BAR

Art.	Length
PN402N200A	200 mm
PN402N400A	400 mm

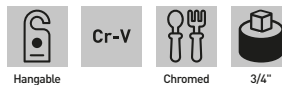
LN400N3/4A
SLIDING T BAR

Length	500 mm
--------	--------

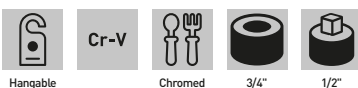
RN4023NA
ADAPTER

Length	50 mm
--------	-------

JN402NA
UNIVERSAL JOINT

Length	110 mm
--------	--------



0795/2

MULTILOCK SOCKET SET

Suitable for metric, inch, torx and XZN bolt.



19 Pcs Carrying case
Cr-V Chromed 1/2"

Sizes	8 - 9 - 10 - 11 - 12 - 13 - 14 - 15 - 16 - 17 - 18 - 19 - 20 - 21 - 22 - 24 - 27 - 30 - 32 mm
Inch size	3/8" - 7/16" - 15/32" - 1/2" - 19/32" - 5/8" - 3/4" - 25/32" - 13/16" - 7/8" - 15/16" - 1-1/16" - 1-13/16" - 1-1/4"
Torx size	E12 - E14 - E16 - E18 - E20 - E22 - E24 - E26 - E28 - E30 - E34 - E38 - E40
XZN size	M12 - M14 - M16 - M18

0195

E-TORX SOCKET SET

Suitable for torx bolt.



28 Pcs Carrying case
Cr-V Chromed 1/4" | 3/8" | 1/2"

Torx size	1/4": E4 - E5 - E6 - E7 - E8 - E10 - E11 3/8": E4 - E5 - E6 - E7 - E8 - E10 - E11 - E12 - E14 - E16 - E18 - E20 1/2": E10 - E11 - E12 - E14 - E16 - E18 - E20 - E22 - E24
-----------	---

SN4E4C013

LOW PROFILE 12 POINT SOCKET SET

Composed of 12 sockets and 1 60t ratchet handle, suitable for operations in small spaces.



13 Pcs Box
Cr-V Chromed 3/8"

Socket	8, 9, 10, 11, 12, 13, 14, 15, 16, 17, 18, 19 mm
--------	---

0795/1

MULTILOCK SOCKET SET

Suitable for metric, inch, torx and XZN bolt.



13 Pcs Carrying case
Cr-V Chromed 1/4"

Sizes	4 - 4,5 - 5 - 5,5 - 6 - 7 - 8 - 9 - 10 - 11 - 12 - 13 - 14 mm
Inch size	5/32" - 7/32" - 1/4" - 5/16" - 11/32" - 3/8" - 7/16" - 15/32" - 1/2"
Torx size	E5 - E6 - E8 - E10 - E12 - E14 - E16 - E18
XZN size	M5 - M6 - M8 - M9 - M10 - M12 - M14 - M16 - M18

SN4E5C012

LOW PROFILE 12 POINT SOCKET SET

Composed of 11 sockets and 1 60t ratchet handle, suitable for operations in small spaces.



12 Pcs Box
Cr-V Chromed 1/4"

Socket	4, 5, 6, 7, 8, 9, 10, 11, 12, 13, 14 mm
--------	---

SN4E3C015

LOW PROFILE 12 POINT SOCKET SET

Composed of 14 sockets and 1 60t ratchet handle, suitable for operations in small spaces.



15 Pcs Box
Cr-V Chromed 1/2"

Socket	8, 10, 11, 12, 13, 14, 15, 17, 18, 19, 21, 22, 23, 24 mm
--------	--

0589

LOW PROFILE GO-THROUGH SPLINE SOCKET SET

Composed of 11 go-through spline sockets, one ratchet handle and accessories, suitable for metric, inch, torx and XZN size, can operate in small spaces.

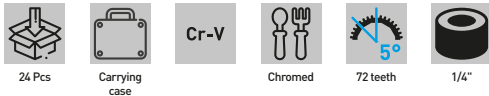

Socket	4.5 - 5 - 5.5 - 6 - 7 - 8 - 9 - 10 - 11 - 12 - 13 mm
Ratchet handle	
Extension	50 mm
Socket	1/4"
Bit holder	
Bits	PH: 1 - 2 - 3 (S2) Torx: T10-T15-T20-T25-T30-T40 (S2)

0624

1/4" DR. SOCKET SET



1/4" Dr. sockets	4 - 4.5 - 5 - 5.5 - 6 - 7 - 8 - 9 - 10 - 11 - 12 - 13 - 14 mm
Sockets with bits	1/4" : T8 - T10 - T15 - T20 - T25 - T30 - T40 - H3 - H4 - H5 - H6 - H7 - H8 - SL4 - SL5.5 - SL7 - PH1 - PH2 - PH3 - PZ1 - PZ2 - PZ3
Ratchet handle	1/4"
Flexible bar	1/4" - 150 mm
1/4" Dr. socket-bars	50 - 100 mm
Socket handle	1/4"
Universal joint	1/4"
Sliding T-bar	1/4"
Hex keys	1,27 - 1,5 - 2 - 2,5 mm

S520

1/4" DR. 6 POINT SAE SOCKET SET



1/4" Dr. sockets	5/32", 3/16", 7/32", 1/4", 9/32" 5/16", 11/32", 3/8", 13/32", 7/16", 15/32", 1/2", 9/16"
Universal joint	1/4"
1/4" Dr. socket-bars	2", 4", 6"
Sliding T-bar	1/4"
Socket handle	1/4"
Ratchet handle	1/4"

0679

3/8" AND 1/4" DR. SOCKET SET



3/8" Dr. sockets	9 - 10 - 11 - 12 - 13 - 14 - 15 - 17 - 19 mm
Spark plug sockets sizes	3/8" : 16 - 21 mm
3/8" Dr. socket-bars	75 - 150 mm
Universal joint	3/8"
Adapter	F. 1/2" - M. 3/8"
Ratchet handle	3/8"
1/4" Dr. sockets	4 - 4,5 - 5 - 5,5 - 6 - 7 - 8 - 9 - 10 - 11 - 12 - 13 mm
Socket handle	1/4"
Adapter	F. 3/8" - M. 1/4"
Bits holder socket	1/4"
Bits	PH1 - PH2 - PH3 - H3 - H4 - H5 - H6 - H7 - SL4 - SL5,5 - SL7



S328

1/2" DR. SOCKET SET



1/2" Dr. sockets	8 - 9 - 10 - 11 - 12 - 13 - 14 - 15 - 16 - 17 - 18 - 19 - 20 - 21 - 22 - 23 - 24 - 27 - 30 - 32 mm
Spark plug sockets sizes	1/2" : 16 - 21 mm
1/2" Dr. socket-bars	75 - 150 - 250 mm
Universal joint	1/2"
Adapter	F. 3/8" - M. 1/2"
Ratchet handle	1/2"

SN4P3N027

1/2" DR. 6 POINT SAE SOCKET SET

Composed of 20 standard sockets, 2 spark plug sockets, 1 ratchet handle, 1 universal joint, 2 extension bars and 1 sliding T-bar.



Standard sockets sizes	5/16", 3/8", 7/16", 15/32", 1/2", 9/16", 19/32", 5/8", 11/16", 3/4", 25/32", 13/16", 7/8", 15/16", 1", 1-1/16", 1-3/16", 1-1/4", 23/32", 1-1/8"
Spark plug sockets sizes	5/8", 13/16"
Extension bars sizes	3", 10"

0620

1/2" DR. SOCKET SET



1/2" Dr. sockets	10 - 11 - 12 - 13 - 14 - 15 - 16 - 17 - 18 - 19 - 20 - 21 - 22 - 23 - 24 - 27 - 30 - 32 mm
Spark plug sockets sizes	1/2" : 21 mm
1/2" Dr. socket-bars	125 - 250 mm
Universal joint	1/2"
Sliding T-bar	1/2"
Ratchet handle	1/2"

0181

3/4" DR. SOCKET SET



Sizes	19 - 21 - 22 - 23 - 24 - 26 - 27 - 30 - 32 - 34 - 36 - 38 - 41 - 46 - 48 - 50 mm
Ratchet handle	3/4"
Sliding T-bar	3/4"
Extension bars	3/4" : 100 - 200 mm

0622
SOCKET TORX BIT SET

Sizes T20 - T25 - T27 - T30 - T40 T45 - T50 - T55 - T60 - T70

S108
1/4" & 1/2" DR. SOCKET SET

1/4" Dr. sockets	4 - 4.5 - 5 - 5.5 - 6 - 7 - 8 - 9 - 10 - 11 - 12 - 13 - 14 mm
1/4" Dr. deep sockets	6 - 7 - 8 - 9 - 10 - 11 - 12 - 13 mm
1/4" Dr. deep sockets	Torx: E4 - E5 - E6 - E7 - E8 mm
1/2" Dr. sockets	10 - 11 - 12 - 13 - 14 - 15 - 16 - 17 - 18 - 19 - 20 - 21 - 22 - 24 - 27 - 30 - 32 mm
1/2" Dr. deep sockets	14 - 15 - 17 - 19 - 22 mm
1/2" Dr. sockets	Torx: E10 - E11 - E12 - E14 - E16 - E18 - E20 - E24
Sockets with bits	1/4" : T8 - T10 - T15 - T20 - T25 - T27 - T30 - H3 - H4 - H5 - H6 - SL4 - SL5.5 - SL6.5 - PH1 - PH2 - Pcs1 - Pcs2
Spark plug sockets sizes	1/2" : 16 - 21 mm
Bits holder socket	1/2"
Bits	5/16" x 30 mm : H7 - H8 - H10 - H12 - H14 - SL8 - SL10 - SL12 - PH3 - PH4 - Pcs3 - Pcs4 - T40 - T45 - T50 - T55 - T60
1/4" Dr. socket-bars	50 - 85 mm
1/2" Dr. socket-bars	125 - 250 mm
Socket handle	1/4"
Adapter	F. 3/8" - M. 1/2"
Universal joint	1/4"
Universal joint	1/2"
Sliding T-bar	1/4"
Ratchet handle	1/4"
Ratchet handle	1/2"
Hex keys	1.5 - 2 - 2.5 mm

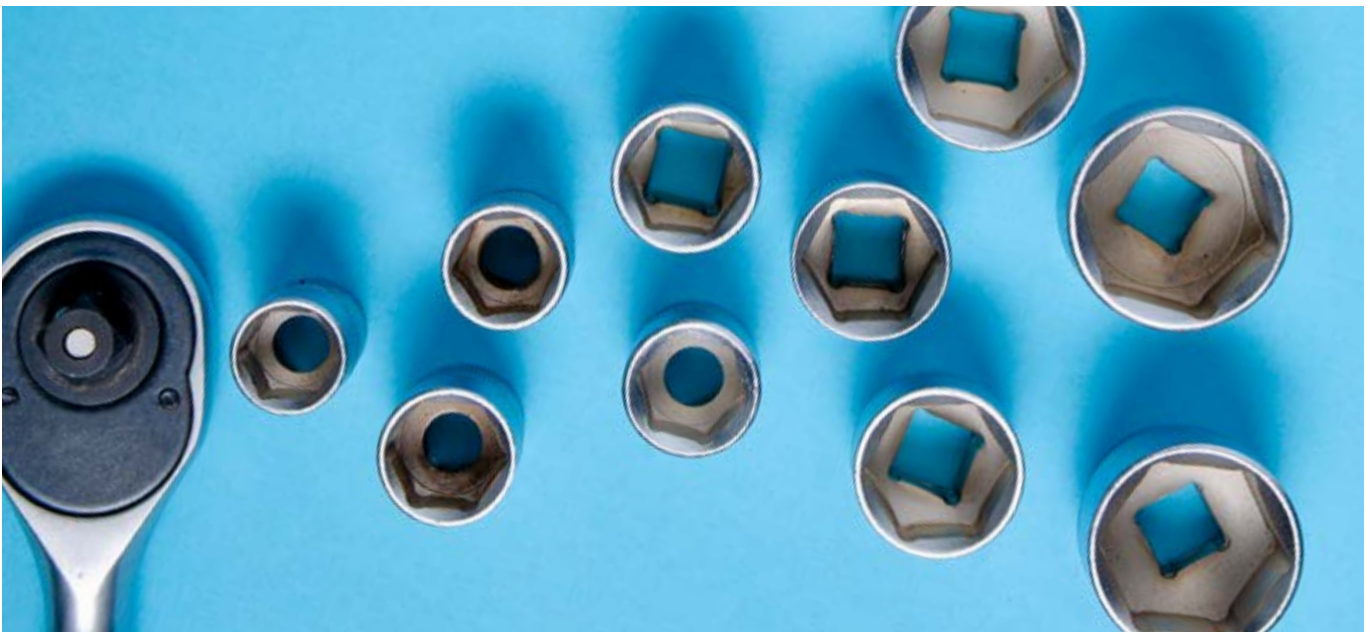



0618

1/2" & 1/4" DR. SOCKET SET



1/4" Dr. sockets	4 - 4.5 - 5 - 5.5 - 6 - 7 - 8 - 9 - 10 - 11 - 12 - 13 - 14 mm
1/4" Dr. deep sockets	6 - 7 - 8 - 9 - 10 - 11 - 12 - 13 mm
Male adapter 1/4" Dr. and 1/4" hex	
1/2" Dr. sockets	10 - 11 - 12 - 13 - 14 - 15 - 16 - 17 - 18 - 19 - 20 - 21 - 22 - 23 - 24 - 27 - 30 - 32 mm
1/2" Dr. deep sockets	14 - 15 - 17 - 19 mm
Flexible bar	1/4" - 150 mm
Sockets with bits	1/4" : T8 - T10 - T15 - T20 - T25 - T30 - H3 - H4 - H5 - H6 - SL4 - SL5.5 - SL7 - PH1 - PH2 - Pcs1 - Pcs2
Spark plug sockets sizes	1/2" : 16 - 21 mm
Socket for 5/16" inserts	1/2"
Bits	5/16" x 30 mm : H8 - H10 - H12 - H14 - SL8 - SL10 - SL12 - PH3 - PH4 - Pcs3 - Pcs4 - T40 - T45 - T50 - T55
1/4" Dr. socket-bars	50 - 100 mm
1/2" Dr. socket-bars	125 - 250 mm
Socket handle	1/4"
Adapter	F. 3/8" - M. 1/2"
Universal joint	1/4"
Universal joint	1/2"
Sliding T-bar	1/4"
Ratchet handle	1/4"
Ratchet handle	1/2"
Hex keys	1.5 - 2 - 2.5 mm



S179

DR. SOCKET SET



1/4" Dr. sockets	4 - 4.5 - 5 - 5.5 - 6 - 7 - 8 - 9 - 10 - 11 - 12 - 13 - 14 mm
1/4" Dr. deep sockets	6 - 7 - 8 - 9 - 10 mm
1/4" Dr. deep sockets	Torx: E4 - E5 - E6 - E7 - E8 mm
1/4" Dr. socket-bars	50 - 100 mm
Sliding T-bar	1/4"
Bits holder socket	1/4"
Sockets with bits	1/4" - Torx: T8 - T9 - T10 - T15 - T20 - T25 - T27 - T30
Sockets with tampered bits	1/4" - Torx: T8H - T9H - T10H - T15H - T20H - T25H - T27H - T30H
Sockets with bits	1/4" : PH0 - PH1 - PH2
Sockets with bits	1/4" : Pcs0 - Pcs1 - Pcs2
Sockets with hex bits	1/4" : 3 - 4 - 5 - 6 mm
Sockets with slotted bits	1/4" : 4 - 5.5 - 6.5 - 7 mm
Universal joint	1/4"
Socket handle	1/4"
Ratchet handle	1/4"
3/8" Dr. sockets	10 - 11 - 12 - 13 - 14 - 15 - 16 - 17 - 18 - 19 mm
3/8" Dr. sockets	Torx: E10 - E11 - E12 - E13
3/8" Dr. deep sockets	10 - 11 - 12 - 13 - 14 - 15 mm
Spark plug sockets sizes	3/8" - 18 mm
3/8" Dr. socket-bars	150 mm
Socket for 5/16" inserts	3/8"
Universal joint	3/8"
Ratchet handle	3/8"
1/2" Dr. sockets	10 - 11 - 12 - 13 - 14 - 15 - 16 - 17 - 18 - 19 - 20 - 21 - 22 - 24 - 27 - 30 - 32 mm
1/2" Dr. deep sockets	16 - 17 - 18 - 19 - 22 mm
1/2" Dr. sockets	Torx: E16 - E18 - E20 - E24
Spark plug sockets sizes	1/2" : 16 - 21 mm
1/2" Dr. socket-bars	125 - 250 mm
Socket for 5/16" inserts	1/2"



Universal joint	1/2"
Adapter	F. 3/8" - M. 1/2"
Ratchet handle	1/2"
Bits	1/4" x 25 mm XZN: M5 - M6 - M8
Bits	1/4" x 25 mm Torx: T5 - T6 - T7 - T8 - T9 - T10 - T15 - T20 - T25 - T27 - T30
Bits	1/4" x 25 mm Ribe: RM5 - RM6 - RM7 - RM8 - RM9
Bits	1/4" x 25 mm Torx "5": TS7 - TS10 - TS15 - TS20 - TS25 - TS27 - TS30 - TS40 - TS45
Bits	5/16" x 30 mm Torx: T40 - T45 - T50 - T55 - T60 - T70
Tampered bits	5/16" x 30 mm Torx: T40H - T45H - T50H - T55H - T60H - T70H
Hex bits	5/16" x 30 mm: 7 - 8 - 10 - 12 - 14 mm
Bits	5/16" x 30 mm: PH3 - PH4
Bits	5/16" x 30 mm: Pcs3 - Pcs4
Slotted bits	5/16" x 30 mm: 8 - 10 - 12 mm
Hex keys	1.3 - 1.5 - 2 - 2.5 - 3 - 4 - 5 mm

BI4E3NX
STANDARD IMPACT SOCKET

Cr-Mo



Phosphated



1/2"

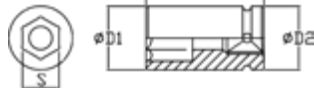

3124



Art.	Size	D1	D2	Length
BI4E3N008	8 mm	15 mm	24 mm	38 mm
BI4E3N009	9 mm	16 mm	24 mm	38 mm
BI4E3N010	10 mm	17,5 mm	24 mm	38 mm
BI4E3N011	11 mm	18,5 mm	24 mm	38 mm
BI4E3N012	12 mm	19,5 mm	24 mm	38 mm
BI4E3N013	13 mm	20,5 mm	24 mm	38 mm
BI4E3N014	14 mm	22 mm	24 mm	38 mm
BI4E3N015	15 mm	24 mm	24 mm	38 mm
BI4E3N016	16 mm	24 mm	24 mm	38 mm
BI4E3N017	17 mm	26 mm	26 mm	38 mm
BI4E3N018	18 mm	28 mm	28 mm	38 mm
BI4E3N019	19 mm	28 mm	28 mm	38 mm
BI4E3N020	20 mm	30 mm	30 mm	38 mm
BI4E3N021	21 mm	30 mm	30 mm	38 mm
BI4E3N022	22 mm	32 mm	30 mm	38 mm
BI4E3N023	23 mm	34 mm	30 mm	38 mm
BI4E3N024	24 mm	34 mm	30 mm	38 mm
BI4E3N025	25 mm	36 mm	30 mm	38 mm
BI4E3N026	26 mm	36 mm	30 mm	38 mm
BI4E3N027	27 mm	38 mm	30 mm	42 mm
BI4E3N028	28 mm	40 mm	30 mm	42 mm
BI4E3N029	29 mm	42 mm	30 mm	42 mm
BI4E3N030	30 mm	42 mm	30 mm	42 mm
BI4E3N031	31 mm	44 mm	30 mm	42 mm
BI4E3N032	32 mm	44 mm	30 mm	44 mm

BI4E3LX
DEEP IMPACT SOCKET

Cr-Mo



Phosphated



1/2"

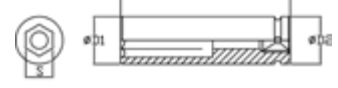

3124



Art.	Size	D1	D2	Length
BI4E3L008	8 mm	15 mm	24 mm	78 mm
BI4E3L009	9 mm	16 mm	24 mm	78 mm
BI4E3L010	10 mm	17,5 mm	24 mm	78 mm
BI4E3L011	11 mm	18,5 mm	24 mm	78 mm
BI4E3L012	12 mm	19,5 mm	24 mm	78 mm
BI4E3L013	13 mm	20,5 mm	24 mm	78 mm
BI4E3L014	14 mm	22 mm	24 mm	78 mm
BI4E3L015	15 mm	24 mm	24 mm	78 mm
BI4E3L016	16 mm	24 mm	24 mm	78 mm
BI4E3L017	17 mm	26 mm	26 mm	78 mm
BI4E3L018	18 mm	28 mm	28 mm	78 mm
BI4E3L019	19 mm	28 mm	28 mm	78 mm
BI4E3L020	20 mm	30 mm	30 mm	78 mm
BI4E3L021	21 mm	30 mm	30 mm	78 mm
BI4E3L022	22 mm	32 mm	30 mm	78 mm
BI4E3L023	23 mm	34 mm	30 mm	78 mm
BI4E3L024	24 mm	34 mm	30 mm	78 mm
BI4E3L025	25 mm	36 mm	30 mm	78 mm
BI4E3L026	26 mm	36 mm	30 mm	78 mm
BI4E3L027	27 mm	38 mm	30 mm	78 mm
BI4E3L028	28 mm	40 mm	30 mm	78 mm
BI4E3L029	29 mm	42 mm	30 mm	78 mm
BI4E3L030	30 mm	42 mm	30 mm	78 mm
BI4E3L031	31 mm	44 mm	30 mm	78 mm
BI4E3L032	32 mm	44 mm	30 mm	78 mm





BI413LOX

IMPACT HEX BIT SOCKET

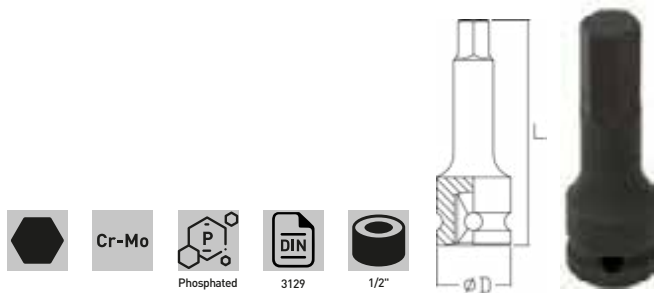

Art.	Size	D	Length
BI413L004	4 mm	25 mm	78 mm
BI413L005	5 mm	25 mm	78 mm
BI413L006	6 mm	25 mm	78 mm
BI413L008	8 mm	25 mm	78 mm
BI413L010	10 mm	25 mm	78 mm
BI413L012	12 mm	25 mm	78 mm
BI413L014	14 mm	25 mm	78 mm
BI413L017	17 mm	25 mm	78 mm
BI413L019	19 mm	25 mm	78 mm

BI423LX

IMPACT TORX BIT SOCKET

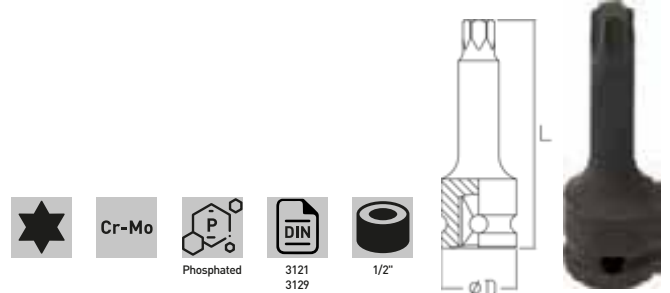

Art.	Size	D	Length
BI423L025	T25	25 mm	78 mm
BI423L027	T27	25 mm	78 mm
BI423L030	T30	25 mm	78 mm
BI423L040	T40	25 mm	78 mm
BI423L045	T45	25 mm	78 mm
BI423L050	T50	25 mm	78 mm
BI423L060	T60	25 mm	78 mm
BI423L070	T70	25 mm	78 mm
BI423L080	T80	25 mm	78 mm

BI433MX

IMPACT RIBE BIT SOCKET

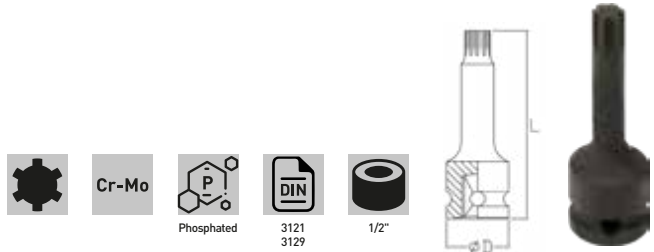

Art.	Size	D	Length
BI433M004	4	25 mm	60 mm
BI433M005	5	25 mm	60 mm
BI433M006	6	25 mm	60 mm
BI433M007	7	25 mm	60 mm
BI433M008	8	25 mm	60 mm
BI433M009	9	25 mm	60 mm
BI433M010	10	25 mm	60 mm
BI433M012	12	25 mm	60 mm
BI433M014	14	25 mm	60 mm
BI433M016	16	25 mm	60 mm
BI433M018	18	25 mm	60 mm

BI443MX

IMPACT XZN BIT SOCKET



Art.	Size	D	Length
BI443M004	4	25 mm	60 mm
BI443M005	5	25 mm	60 mm
BI443M006	6	25 mm	60 mm
BI443M008	8	25 mm	60 mm
BI443M010	10	25 mm	60 mm
BI443M012	12	25 mm	60 mm
BI443M014	14	25 mm	60 mm
BI443M016	16	25 mm	60 mm
BI443M018	18	25 mm	60 mm
BI443M020	20	25 mm	60 mm

PI403X

IMPACT EXTENSION BAR

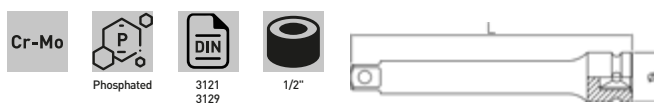

Art.	D	Length
PI403075	25 mm	75 mm
PI403125	25 mm	125 mm
PI403150	25 mm	150 mm
PI403250	25 mm	250 mm

PI453X

QUICK RELEASE IMPACT EXTENSION BAR

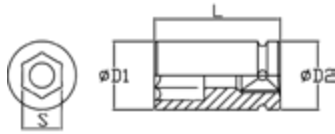
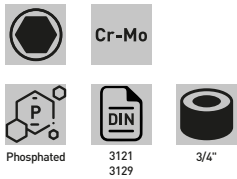

Art.	D	Length
PI453075	25 mm	75 mm
PI453150	25 mm	125 mm
PI453250	25 mm	250 mm

BI4E2NX
STANDARD IMPACT SOCKET

Art.	Size	D1	D2	Length
BI4E2N018	18 mm	30 mm	44 mm	51 mm
BI4E2N019	19 mm	32 mm	44 mm	51 mm
BI4E2N020	20 mm	33 mm	44 mm	51 mm
BI4E2N021	21 mm	35 mm	44 mm	51 mm
BI4E2N022	22 mm	36 mm	44 mm	51 mm
BI4E2N023	23 mm	38 mm	44 mm	51 mm
BI4E2N024	24 mm	39 mm	44 mm	51 mm
BI4E2N025	25 mm	41 mm	44 mm	54 mm
BI4E2N026	26 mm	41 mm	44 mm	54 mm
BI4E2N027	27 mm	42 mm	44 mm	54 mm
BI4E2N028	28 mm	44 mm	44 mm	54 mm
BI4E2N029	29 mm	46 mm	44 mm	54 mm
BI4E2N030	30 mm	46 mm	44 mm	54 mm
BI4E2N032	32 mm	48 mm	44 mm	57 mm
BI4E2N033	33 mm	50 mm	44 mm	57 mm
BI4E2N034	34 mm	52 mm	44 mm	57 mm
BI4E2N035	35 mm	52 mm	44 mm	57 mm
BI4E2N036	36 mm	54 mm	44 mm	57 mm
BI4E2N038	38 mm	56 mm	44 mm	57 mm
BI4E2N041	41 mm	60 mm	44 mm	58 mm
BI4E2N046	46 mm	66 mm	44 mm	68 mm
BI4E2N050	50 mm	71 mm	54 mm	68 mm
BI4E2N055	55 mm	77 mm	54 mm	73 mm
BI4E2N060	60 mm	84 mm	54 mm	75 mm
BI4E2N065	65 mm	88 mm	54 mm	78 mm

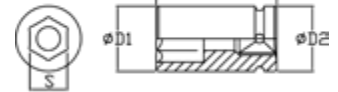
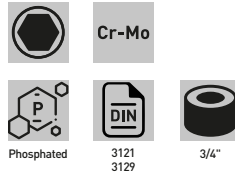
BI4E2LX
DEEP IMPACT SOCKET

Art.	Size	D1	D2	Length
BI4E2L018	18 mm	30 mm	44 mm	90 mm
BI4E2L019	19 mm	32 mm	44 mm	90 mm
BI4E2L020	20 mm	33 mm	44 mm	90 mm
BI4E2L021	21 mm	35 mm	44 mm	90 mm
BI4E2L022	22 mm	36 mm	44 mm	90 mm
BI4E2L023	23 mm	38 mm	44 mm	90 mm
BI4E2L024	24 mm	39 mm	44 mm	90 mm
BI4E2L025	25 mm	41 mm	44 mm	90 mm
BI4E2L026	26 mm	41 mm	44 mm	90 mm
BI4E2L027	27 mm	42 mm	44 mm	90 mm
BI4E2L028	28 mm	44 mm	44 mm	90 mm
BI4E2L029	29 mm	46 mm	44 mm	90 mm
BI4E2L030	30 mm	46 mm	44 mm	90 mm
BI4E2L032	32 mm	48 mm	44 mm	90 mm
BI4E2L033	33 mm	50 mm	44 mm	90 mm
BI4E2L034	34 mm	52 mm	44 mm	90 mm
BI4E2L035	35 mm	52 mm	44 mm	90 mm
BI4E2L036	36 mm	54 mm	44 mm	90 mm
BI4E2L038	38 mm	56 mm	44 mm	90 mm
BI4E2L041	41 mm	60 mm	44 mm	90 mm
BI4E2L046	46 mm	66 mm	44 mm	90 mm
BI4E2L050	50 mm	71 mm	54 mm	90 mm

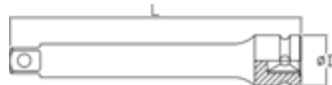
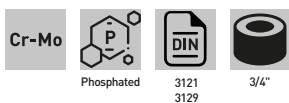
PI402X
IMPACT EXTENSION BAR

Art.	D	Length
PI402175	44 mm	175 mm
PI402200	44 mm	200 mm
PI402300	44 mm	300 mm
PI402400	44 mm	400 mm





BI4E1NX

STANDARD IMPACT SOCKET



Art.	Size	D1	D2	Length
BI4E1N021	21 mm	38 mm	54 mm	58 mm
BI4E1N022	22 mm	39 mm	54 mm	58 mm
BI4E1N023	23 mm	41 mm	54 mm	58 mm
BI4E1N024	24 mm	42 mm	54 mm	58 mm
BI4E1N025	25 mm	43 mm	54 mm	58 mm
BI4E1N026	26 mm	44 mm	54 mm	58 mm
BI4E1N027	27 mm	46 mm	54 mm	58 mm
BI4E1N028	28 mm	47 mm	54 mm	58 mm
BI4E1N029	29 mm	48 mm	54 mm	58 mm
BI4E1N030	30 mm	49 mm	54 mm	62 mm
BI4E1N031	31 mm	50 mm	54 mm	62 mm
BI4E1N032	32 mm	52 mm	54 mm	62 mm
BI4E1N033	33 mm	54 mm	54 mm	62 mm
BI4E1N034	34 mm	54 mm	54 mm	62 mm
BI4E1N035	35 mm	54 mm	54 mm	62 mm
BI4E1N036	36 mm	56 mm	54 mm	65 mm
BI4E1N037	37 mm	57 mm	54 mm	65 mm
BI4E1N038	38 mm	58 mm	54 mm	65 mm
BI4E1N039	39 mm	59 mm	54 mm	65 mm
BI4E1N040	40 mm	60 mm	54 mm	65 mm
BI4E1N041	41 mm	61 mm	54 mm	68 mm
BI4E1N042	42 mm	64 mm	54 mm	68 mm
BI4E1N043	43 mm	66 mm	54 mm	68 mm
BI4E1N044	44 mm	66 mm	54 mm	68 mm
BI4E1N045	45 mm	67 mm	54 mm	68 mm
BI4E1N046	46 mm	68 mm	54 mm	72 mm
BI4E1N047	47 mm	69 mm	54 mm	72 mm
BI4E1N048	48 mm	70 mm	54 mm	72 mm
BI4E1N050	50 mm	74 mm	54 mm	75 mm
BI4E1N052	52 mm	75 mm	54 mm	75 mm
BI4E1N054	54 mm	78 mm	54 mm	80 mm
BI4E1N055	55 mm	80 mm	54 mm	83 mm
BI4E1N056	56 mm	81 mm	54 mm	83 mm
BI4E1N060	60 mm	86 mm	54 mm	87 mm
BI4E1N065	65 mm	92 mm	54 mm	90 mm
BI4E1N070	70 mm	97 mm	54 mm	93 mm
BI4E1N075	75 mm	104 mm	86 mm	95 mm
BI4E1N080	80 mm	112 mm	86 mm	95 mm
BI4E1N085	85 mm	115 mm	86 mm	100 mm
BI4E1N090	90 mm	124 mm	86 mm	105 mm
BI4E1N095	95 mm	130 mm	86 mm	105 mm
BI4E1N100	100 mm	135 mm	86 mm	105 mm

BI4E1LX

DEEP IMPACT SOCKET



Art.	Size	D1	D2	Length
BI4E1L021	21 mm	38 mm	54 mm	90 mm
BI4E1L022	22 mm	39 mm	54 mm	90 mm
BI4E1L023	23 mm	41 mm	54 mm	90 mm
BI4E1L024	24 mm	42 mm	54 mm	90 mm
BI4E1L027	27 mm	46 mm	54 mm	90 mm
BI4E1L028	28 mm	47 mm	54 mm	90 mm
BI4E1L030	30 mm	49 mm	54 mm	90 mm
BI4E1L032	32 mm	52 mm	54 mm	90 mm
BI4E1L033	33 mm	54 mm	54 mm	90 mm
BI4E1L034	34 mm	54 mm	54 mm	90 mm
BI4E1L035	35 mm	54 mm	54 mm	90 mm
BI4E1L036	36 mm	56 mm	54 mm	90 mm
BI4E1L038	38 mm	58 mm	54 mm	95 mm
BI4E1L039	39 mm	59 mm	54 mm	95 mm
BI4E1L040	40 mm	60 mm	54 mm	95 mm
BI4E1L041	41 mm	61 mm	54 mm	95 mm
BI4E1L042	42 mm	64 mm	54 mm	95 mm
BI4E1L043	43 mm	66 mm	54 mm	95 mm
BI4E1L044	44 mm	66 mm	54 mm	95 mm
BI4E1L045	45 mm	67 mm	54 mm	95 mm
BI4E1L046	46 mm	68 mm	54 mm	95 mm
BI4E1L048	48 mm	70 mm	54 mm	100 mm
BI4E1L049	49 mm	72 mm	54 mm	100 mm
BI4E1L050	50 mm	74 mm	54 mm	100 mm
BI4E1L051	51 mm	74 mm	54 mm	100 mm
BI4E1L052	52 mm	74 mm	54 mm	100 mm
BI4E1L054	54 mm	78 mm	54 mm	100 mm
BI4E1L055	55 mm	80 mm	54 mm	105 mm
BI4E1L057	57 mm	82 mm	54 mm	105 mm
BI4E1L060	60 mm	86 mm	54 mm	110 mm
BI4E1L065	65 mm	92 mm	54 mm	115 mm
BI4E1L070	70 mm	97 mm	54 mm	120 mm
BI4E1L075	75 mm	104 mm	86 mm	135 mm
BI4E1L080	80 mm	112 mm	86 mm	135 mm
BI4E1L085	85 mm	115 mm	86 mm	140 mm
BI4E1L090	90 mm	124 mm	86 mm	140 mm
BI4E1L095	95 mm	130 mm	86 mm	140 mm

I340

STANDARD & DEEP IMPACT SOCKET SET

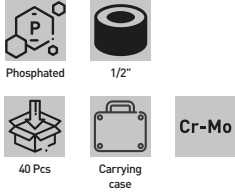

1/2" Dr. sockets	9 - 10 - 11 - 12 - 13 - 14 - 15 - 16 - 17 - 18 - 19 - 20 - 21 - 22 - 23 - 24 - 26 - 27 - 30 mm
1/2" Dr. deep sockets	9 - 10 - 11 - 12 - 13 - 14 - 15 - 16 - 17 - 18 - 19 - 20 - 21 - 22 - 23 - 24 - 26 - 27 - 30 mm
Universal joint	1/2"
1/2" Dr. socket-bars	125 mm

SI4E3N013

STANDARD IMPACT SOCKET SET

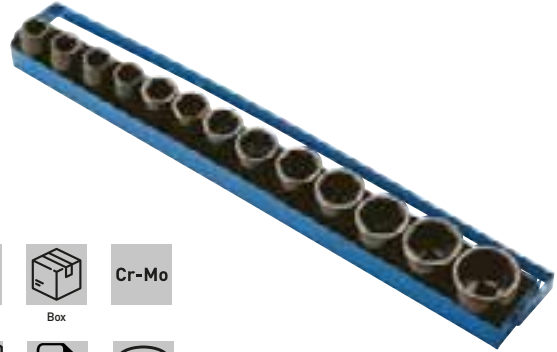
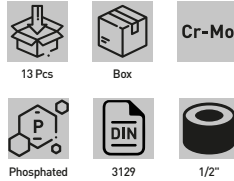

Socket	10, 11, 12, 13, 14, 16, 17, 19, 21, 22, 24, 27, 30 mm
--------	---

SI413M006

IMPACT HEX BIT SOCKET SET

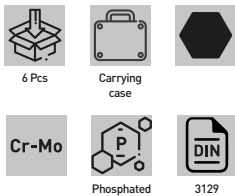

Socket	8, 10, 12, 14, 17, 19 mm
Length	60 mm

SI423M006

IMPACT TORX BIT SOCKET SET

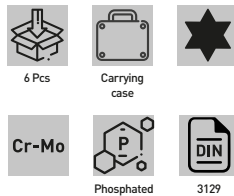

Length	60 mm
Socket	T40, T45, T50, T55, T60, T70

0341-X

IMPACT HEX SOCKET WITH PLASTIC SLEEVE



Art.	Size	Length
0341/17	17 mm	87 mm
0341/19	19 mm	87 mm
0341/21	21 mm	87 mm
0341/22	22 mm	87 mm
0341/24	24 mm	87 mm

0341

DEEP IMPACT HEX SOCKET SET WITH PLASTIC SLEEVE

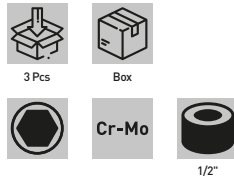

Sizes	17 - 19 - 21 mm
Length	87 mm



0341/5S

IMPACT HEX SOCKET SET WITH PLASTIC SLEEVE

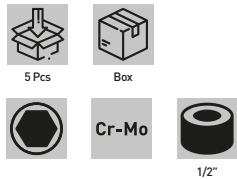

Sizes	17 - 19 - 21 - 22 - 24 mm
Length	87 mm

0341/3LS

IMPACT HEX SOCKET SET WITH PLASTIC SLEEVE

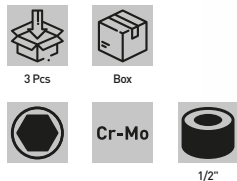

Sizes	17 - 19 - 21 mm
Length	150 mm

I306

LONG IMPACT SOCKET SET

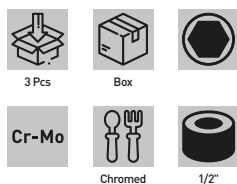

Sizes	17 - 19 - 21 mm
Length	150 mm

0341-XL

LONG IMPACT HEX SOCKET WITH PLASTIC SLEEVE

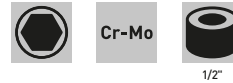

Art.	Size	Length
0341/17L	17 mm	150 mm
0341/19L	19 mm	150 mm
0341/21L	21 mm	150 mm

0341-SX

PLASTIC SLEEVE FOR HEX IMPACT SOCKETS



Plastic

Art.	Size
0341/S19	19 mm
0341/S21	21 mm
0341/S22	22 mm
0341/S24	24 mm

I217

METRIC STANDARD IMPACT SOCKET SET

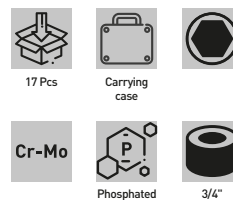

Sizes	19 - 21 - 22 - 24 - 27 - 30 - 32 - 33 - 34 - 35 - 36 - 38 - 40 - 41 - 46 - 50 - 55 mm
-------	---

SI4E2N008

STANDARD IMPACT SOCKET SET

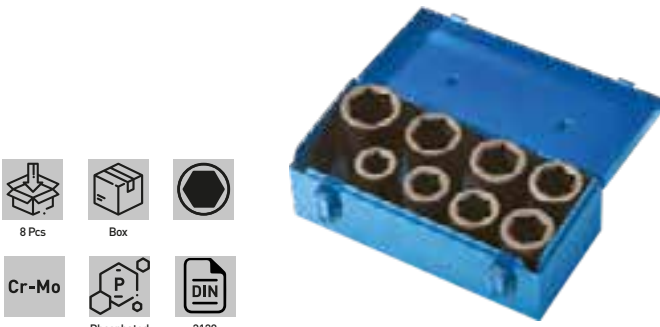

8 Pcs Box Cr-Mo Phosphated 3129

Socket 26, 27, 29, 30, 32, 35, 36, 38 mm

I109

IMPACT SOCKET SET



9 Pcs Carrying case Cr-Mo Phosphated 3129 1"

1" Dr. sockets 21 - 22 - 24 - 26 - 30 - 38 mm
1" Dr. deep sockets 27 - 28 - 32 mm

SI4E1N008

STANDARD IMPACT SOCKET SET

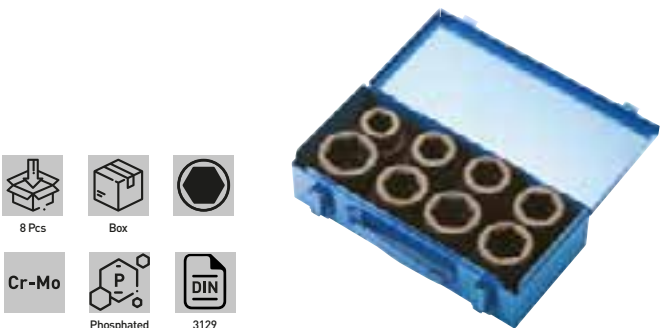

8 Pcs Box Cr-Mo Phosphated 3129

Socket 24, 27, 30, 32, 33, 36, 38, 41 mm

SI40N006

IMPACT ADAPTER SET



6 Pcs Box Cr-Mo Phosphated

Sizes 1/4" int. - 3/8" ext.; 3/8" int. - 1/4" ext.; 3/8" int. - 1/2" ext.; 1/2" int. - 3/8" ext.; 1/2" int. - 3/4" ext.
Blow mould case 126 x 100 x 52 mm

PI401X

IMPACT EXTENSION BAR



Cr-Mo Phosphated 3121 3129 1"

Art.	D	Length
PI401175	54 mm	175 mm
PI401200	54 mm	200 mm
PI401250	54 mm	250 mm
PI401300	54 mm	300 mm
PI401400	54 mm	400 mm

JI40XL

IMPACT UNIVERSAL JOINT

Heavy duty, 3/4" dr., made of 42CRMO2 alloy steel.



Cr-Mo Phosphated

Art.	Dr.	Length	D
JI401L	1"	130 mm	54 mm
JI402L	3/4"	105 mm	44 mm

JI40XN

IMPACT UNIVERSAL JOINT

1" dr., made of 42crmo2 alloy steel.



Cr-Mo Phosphated

Art.	Dr.	D	Length
JI401N	1"	54 mm	115 mm
JI402N	3/4"	44 mm	90 mm
JI403N	1/2"	30 mm	63 mm

RI40X

IMPACT ADAPTER



Cr-Mo Phosphated 3121

Art.	Female junction	Shank	D	Length
RI4012N	1"	3/4"	54 mm	70 mm
RI4021N	3/4"	1"	44 mm	63 mm
RI4023N	3/4"	1/2"	44 mm	58 mm
RI4032N	1/2"	3/4"	30 mm	48 mm



0088

MAGNETIC EXTRACTOR WITH LIGHT



Hangable

Alu

Aluminum

Sizes $\varnothing 9 / 17 \times 430$ mm
Not included batteries 2 x 1.5 VAA

0456

O RING HOOK SET

Equipped of hex handle with magnet.



4 Pcs



Hangable



Steel



Chromed

Handle dimensions 8 x 90 mm

0471

O-RING REMOVAL SET

Suitable for removing motor seals.

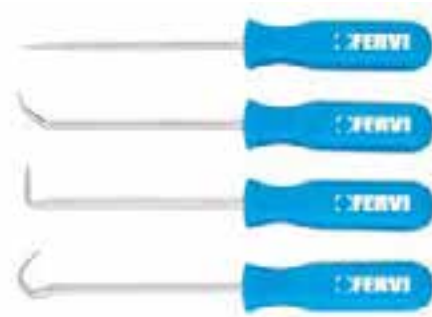

4 Pcs



Hangable



Steel



Chromed

Length 135 mm

E003

HSS SCREW EXTRACTOR SET



5 Pcs



Hangable

HSS



1/4"

num. 0	2-3 mm
num. 1	4-5 mm
num. 2	6-8 mm
num. 3	8-10 mm
num. 4	10-12 mm

E001

SCREW EXTRACTOR SET



5 Pcs



Box



Steel

num. 1	M3 - M6
num. 2	M6 - M8
num. 3	M8 - M11
num. 4	M11 - M14
num. 5	M14 - M18

E005

BOLT REMOVER SET

External hex.



11 Pcs



Box

Cr-Mo



3/8"

Sizes 9 - 10 - 11 - 12 - 13 - 14 - 15 - 16 - 17 - 19 mm
Height 27 mm

E191-

3 JAW GEAR PULLER



Art.	Dimensions
E191/120	Max Ø 120 mm - h 101 mm
E191/200	Max Ø 200 mm - h 150 mm

E190-

2 JAW GEAR PULLER



Art.	Dimensions
E190/080	Max Ø 80 mm - h 100 mm
E190/130	Max Ø 130 mm - h 100 mm
E190/160	Max Ø 160 mm - h 150 mm
E190/200	Max Ø 200 mm - h 150 mm

E190-BX

EXTENDED JAWS



Art.	Length
E190/B2	300 mm

**CB01-****NUT DRIVER WITH PLASTIC HANDLE**

Ansi.

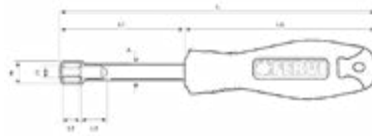

Hangable



Cr-V



Chromed

Art.	Size	L	L1	L2	L3	L4	A	B	C
CB01/04	4 mm	185 mm	75 mm	4 ~ 5 mm	20,5 mm	110 mm	ø 5,9 mm	ø 7 mm	ø 3,3 mm
CB01/05	5 mm	185 mm	75 mm	4,5 ~ 5,5 mm	20 mm	110 mm	ø 5,9 mm	ø 8,3 mm	ø 3,7 mm
CB01/055	5,5 mm	185 mm	75 mm	5,5 ~ 6,5 mm	19 mm	110 mm	ø 5,9 mm	ø 9 mm	ø 3,7 mm
CB01/06	6 mm	185 mm	75 mm	6,5 ~ 7,5 mm	18 mm	110 mm	ø 5,9 mm	ø 9,5 mm	ø 3,7 mm
CB01/07	7 mm	185 mm	75 mm	7,5 ~ 8,5 mm	17 mm	110 mm	ø 5,9 mm	ø 10,5 mm	ø 3,7 mm
CB01/08	8 mm	185 mm	75 mm	8,5 ~ 9,5 mm	16 mm	110 mm	ø 7,2 mm	ø 11,9 mm	ø 5 mm
CB01/09	9 mm	185 mm	75 mm	8,5 ~ 9,5 mm	16 mm	110 mm	ø 7,2 mm	ø 12,8 mm	ø 5 mm
CB01/10	10 mm	185 mm	75 mm	10,5 ~ 11,5 mm	14 mm	110 mm	ø 9,3 mm	ø 14,1 mm	ø 7 mm
CB01/11	11 mm	185 mm	75 mm	10,5 ~ 11,5 mm	14 mm	110 mm	ø 9,3 mm	ø 15 mm	ø 7 mm
CB01/12	12 mm	185 mm	75 mm	10,5 ~ 11,5 mm	14 mm	110 mm	ø 9,3 mm	ø 16 mm	ø 7 mm
CB01/13	13 mm	185 mm	75 mm	11,5 ~ 12,5 mm	14 mm	110 mm	ø 11 mm	ø 17 mm	ø 8,5 mm

CB02-**HOLLOW NUT DRIVER WITH PLASTIC HANDLE**

Ansi.

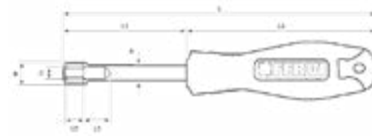

Hangable



Cr-V



Chromed

Art.	Size	L	L1	L2	L3	L4	A	B	C
CB02/04	4 mm	185 mm	75 mm	4 ~ 5 mm	105,5 mm	110 mm	ø 7,2 mm	ø 7 mm	ø 3,3 mm
CB02/05	5 mm	185 mm	75 mm	4,5 ~ 5,5 mm	105 mm	110 mm	ø 7,2 mm	ø 8,3 mm	ø 3,7 mm
CB02/055	5,5 mm	185 mm	75 mm	5,5 ~ 6,5 mm	104 mm	110 mm	ø 7,2 mm	ø 9 mm	ø 3,7 mm
CB02/06	6 mm	185 mm	75 mm	6,5 ~ 7,5 mm	103 mm	110 mm	ø 7,2 mm	ø 9,5 mm	ø 3,7 mm
CB02/07	7 mm	185 mm	75 mm	7,5 ~ 8,5 mm	102 mm	110 mm	ø 7,2 mm	ø 10,5 mm	ø 3,7 mm
CB02/08	8 mm	185 mm	75 mm	8,5 ~ 9,5 mm	101 mm	110 mm	ø 9,3 mm	ø 11,9 mm	ø 5 mm
CB02/09	9 mm	185 mm	75 mm	8,5 ~ 9,5 mm	101 mm	110 mm	ø 9,3 mm	ø 12,8 mm	ø 5 mm
CB02/10	10 mm	185 mm	75 mm	10,5 ~ 11,5 mm	100 mm	110 mm	ø 9,3 mm	ø 14,1 mm	ø 7 mm
CB02/11	11 mm	185 mm	75 mm	10,5 ~ 11,5 mm	100 mm	110 mm	ø 11 mm	ø 15 mm	ø 7 mm
CB02/12	12 mm	185 mm	75 mm	10,5 ~ 11,5 mm	100 mm	110 mm	ø 11 mm	ø 16 mm	ø 7 mm
CB02/13	13 mm	185 mm	75 mm	11,5 ~ 12,5 mm	99 mm	110 mm	ø 11 mm	ø 17 mm	ø 8,5 mm

CBF1-**FLEXIBLE NUT DRIVER WITH PLASTIC HANDLE**

Ansi.

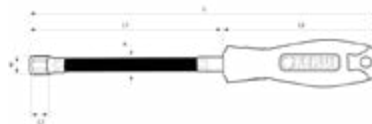

Hangable



Cr-V

Art.	Size	L	L1	L2	L3	A	B
CBF1/05	5 mm	265 mm	150 mm	9,5 mm	115 mm	ø 11 mm	ø 11,8 mm
CBF1/055	5,5 mm	265 mm	150 mm	9,5 mm	115 mm	ø 11 mm	ø 11,8 mm
CBF1/06	6 mm	265 mm	150 mm	9,5 mm	115 mm	ø 11 mm	ø 11,8 mm
CBF1/07	7 mm	265 mm	150 mm	9,5 mm	115 mm	ø 11 mm	ø 11,8 mm
CBF1/08	8 mm	265 mm	150 mm	9,5 mm	115 mm	ø 11 mm	ø 11,8 mm
CBF1/09	9 mm	265 mm	150 mm	9,5 mm	115 mm	ø 11 mm	ø 13 mm
CBF1/10	10 mm	265 mm	150 mm	10 mm	115 mm	ø 11 mm	ø 14,5 mm
CBF1/11	11 mm	265 mm	150 mm	9 mm	115 mm	ø 11 mm	ø 15,9 mm
CBF1/12	12 mm	265 mm	150 mm	9 mm	115 mm	ø 11 mm	ø 17 mm
CBF1/13	13 mm	265 mm	150 mm	8,5 mm	115 mm	ø 11 mm	ø 17,8 mm



CBF1/10P

FLEXIBLE NUT DRIVER SET WITH PLASTIC HANDLE

Ansi, bicomponent.



Sizes 5 - 5.5 - 6 - 7 - 8 - 9 - 10 - 11 - 12 - 13 mm

CB01/04P

NUT DRIVER SET WITH PLASTIC HANDLE

Ansi, bicomponent.



Sizes 10 - 11 - 12 - 13 mm

CB01/07P

NUT DRIVER SET WITH PLASTIC HANDLE

Ansi, bicomponent.



Sizes 4 - 5 - 5.5 - 6 - 7 - 8 - 9 mm

CB01/11P

NUT DRIVER SET WITH PLASTIC HANDLE

Ansi, bicomponent.



Sizes 4 - 5 - 5.5 - 6 - 7 - 8 - 9 - 10 - 11 - 12 - 13 mm

CB02/04P

HOLLOW NUT DRIVER SET WITH PLASTIC HANDLE

Ansi, bicomponent with deep hole.



Sizes 10 - 11 - 12 - 13 mm

CB02/07P

HOLLOW NUT DRIVER SET WITH PLASTIC HANDLE

Ansi, bicomponent with deep hole.



Sizes 4 - 5 - 5.5 - 6 - 7 - 8 - 9 - 10 mm

CB02/11P

HOLLOW NUT DRIVER SET WITH PLASTIC HANDLE

Ansi, bicomponent with deep hole.



Sizes 4 - 5 - 5.5 - 6 - 7 - 8 - 9 - 10 - 11 - 12 - 13 mm



DIN 2380-1, with black blade and tricomponent handle made of highly elastic TPR resin and oil-resistant polypropylene material. The diamond tip allows a perfect grip, avoiding to ruin the head of the screw. This type of tip is also very effective with already ruined screws.



D883-

ELECTRICIAN FLAT SCREWDRIVER WITH DIAMOND TIP

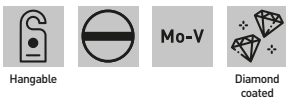

Art.	Size	Pole length	Total length
D883/3075	3 mm	75 mm	115 mm
D883/4100	4 mm	100 mm	145 mm

D884/6038

FLAT SCREWDRIVER WITH DIAMOND TIP

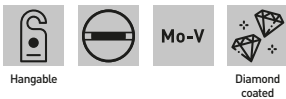

Size	6 mm
Pole length	38 mm
Total length	70 mm

D882/2038

CROSS SCREWDRIVER PH WITH DIAMOND TIP



Size	PH 2
Pole length	38 mm
Total length	70 mm

D885/2038

CROSS SCREWDRIVER PZ WITH DIAMOND TIP



Size	PZ 2
Pole length	38 mm
Total length	70 mm

D884-

FLAT SCREWDRIVER WITH DIAMOND TIP



Art.	Size	Pole length	Total length
D884/3075	3 mm	75 mm	115 mm
D884/4100	4 mm	100 mm	180 mm
D884/5125	5 mm	125 mm	230 mm
D884/6150	6 mm	150 mm	260 mm
D884/8150	8 mm	150 mm	210 mm

D882-

CROSS SCREWDRIVER PH WITH DIAMOND TIP



Art.	Size	Pole length	Total length
D882/1075	PH 1	75 mm	180 mm
D882/2100	PH 2	100 mm	210 mm
D882/3150	PH 3	150 mm	270 mm

D885-

CROSS SCREWDRIVER PZ WITH DIAMOND TIP



Art.	Size	Pole length	Total length
D885/1075	PZ 1	75 mm	120 mm
D885/2100	PZ 2	100 mm	150 mm
D885/3150	PZ 3	150 mm	210 mm

D880/006

DIAMOND TIP SCREWDRIVER SET



Sizes Slot	(-) 4 x 100 mm, (-) 5 x 125 mm, (-) 6 x 150 mm
Cross	(+) PH 1 x 75 mm, (+) PH 2 x 100 mm, (+) PH 3 x 150 mm

C883-
ELECTRICIAN SCREWDRIVER, HANGING PACKAGE

Slotted, with black phosphatized magnetic tip, handle made of high elastic resin TPR and polypropylene material oil resistant.

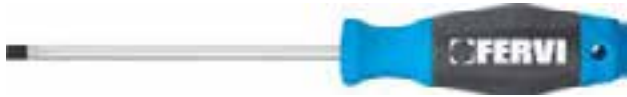

Art.	Size	Pole length
C883/3075	3 mm	75 mm
C883/4100	4 mm	100 mm

C884-
SLOTTED SCREWDRIVER, HANGING PACKAGE

Slotted, with black phosphatized magnetic tip, handle made of high elastic resin TPR and polypropylene material oil resistant.

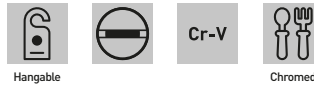

Art.	Size	Pole length
C884/3075	3 mm	75 mm
C884/4100	4 mm	100 mm
C884/5125	5 mm	125 mm
C884/6150	6 mm	150 mm
C884/8150	8 mm	150 mm

C884/6038
SLOTTED SCREWDRIVER, HANGING PACKAGE

With black phosphatized magnetic tip, handle made of high elastic resin TPR and polypropylene material oil resistant.

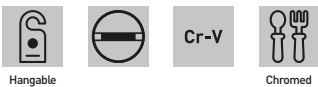

Size	6 mm
Pole length	38 mm

C882-
CROSS SCREWDRIVER PH, HANGING PACKAGE

With black phosphatized magnetic tip, handle made of high elastic resin TPR and polypropylene material oil resistant.



Art.	Size	Pole length
C882/1075	PH 1	75 mm
C882/2100	PH 2	100 mm
C882/3150	PH 3	150 mm

C882/2038
CROSS SCREWDRIVER PH, HANGING PACKAGE

With black phosphatized magnetic tip, handle made of high elastic resin TPR and polypropylene material oil resistant.



Size	PH 2
Pole length	38 mm

C885-
CROSS SCREWDRIVER PZ, HANGING PACKAGE

With black phosphatized magnetic tip, handle made of high elastic resin TPR and polypropylene material oil resistant.



Art.	Size	Pole length
C885/1075	PZ 1	75 mm
C885/2100	PZ 2	100 mm
C885/3150	PZ 3	150 mm



C885/2038

CROSS SCREWDRIVER PZ, HANGING PACKAGE

With black phosphatized magnetic tip, handle made of high elastic resin TPR and polypropylene material oil resistant.



Size	PZ 2
Pole length	38 mm

C880/006

SCREWDRIVER SET

With black phosphatized magnetic tip, handle made of high elastic resin TPR and polypropylene material oil resistant.

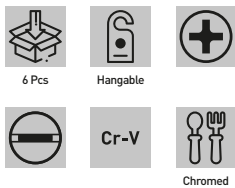

Sizes Slot	(-) 4 x 100 mm, (-) 5 x 125 mm, (-) 6 x 150 mm
Cross	(+) PH 1 x 75 mm, (+) PH 2 x 100 mm, (+) PH 3 x 150 mm

0633

SCREWDRIVER SET

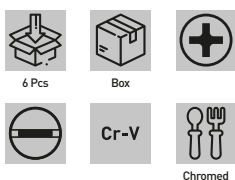

Sizes Slot	(-) 5,0x1,0x75 mm, (-) 6,0x1,2x100 mm, (-) 6,0x1,2x125 mm, (-) 8,0x1,2x150 mm
Cross	(+) PH 1x5x75 mm, (+) PH 2x6x100 mm

C881-

TORX SCREWDRIVER, HANGING PACKAGE

With black phosphatized magnetic tip, handle made of high elastic resin TPR and polypropylene material oil resistant.



Art.	Sizes	Pole length	Total length
C881/07075	T7	75 mm	160 mm
C881/08075	T8	75 mm	160 mm
C881/10075	T10	75 mm	160 mm
C881/15100	T15	100 mm	200 mm
C881/20100	T20	100 mm	200 mm
C881/25125	T25	125 mm	225 mm
C881/27125	T27	125 mm	225 mm
C881/30150	T30	150 mm	260 mm
C881/35150	T35	150 mm	260 mm
C881/40150	T40	150 mm	260 mm

C881/006

TORX SCREWDRIVER SET

With black phosphatized magnetic tip, handle made of high elastic resin TPR and polypropylene material oil resistant.

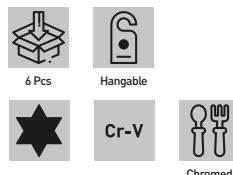

Torx size	T10x75 mm, T15x100 mm, T20x100 mm, T25x125 mm, T27x125 mm, T30x150 mm
-----------	---

0634

SCREWDRIVER SET WITH STEEL HEAD

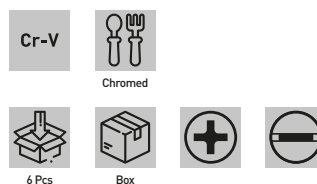

Sizes Slot	(-) 4x0,8x75 mm, (-) 5,5x1,0x100 mm, (-) 6,5x1,2x150 mm
Cross	(+) PH 0x3x75 mm, (+) PH 1x5x100 mm, (+) PH 2x6x125 mm

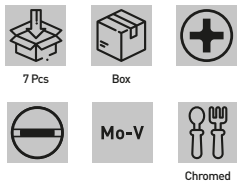
0880/307
SCREWDRIVER SET

Slotted (-) 3,0x0,5x75 mm, (-) 4,0x0,8x100 mm, (-) 5,5x1,0x125 mm, (-) 6,5x1,2x150 mm, (-) 8,0x1,2x150 mm
Cross (+) PH 1x80 mm, (+) PH 2x100 mm

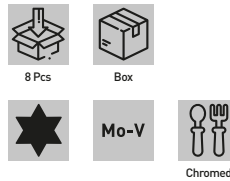
0881/008
SCREWDRIVER TORX SET

Tee star T 7x60 - T 8x60 - T 9x60 - T 10x80 - T 15x80 - T 20x100 - T 25x100 - T 30x115 mm

C182-
INSULATED CROSS SCREWDRIVER

1000V IEC 60900, with black phosphatized magnetic tip and polypropylene material oil resistant bi-color handle.



Art.	Size	Pole length	Total length
C182/0060	PH0 x 3 mm	60 mm	160 mm
C182/1080	PH1 x 4.5 mm	80 mm	185 mm
C182/2100	PH2 x 6 mm	100 mm	210 mm
C182/3150	PH3 x 8 mm	150 mm	265 mm

C183-
INSULATED SLOT SCREWDRIVER

1000V IEC 60900, with black phosphatized magnetic tip and polypropylene material oil resistant bi-color handle.



Art.	Size	Pole length	Total length
C183/25075	0.4 x 2.5 mm	75 mm	175 mm
C183/30100	0.6 x 3 mm	100 mm	200 mm
C183/40100	0.8 x 4 mm	100 mm	200 mm
C183/55125	1 x 5.5 mm	125 mm	230 mm
C183/65150	1.2 x 6.5 mm	150 mm	260 mm
C183/80175	1.6 x 8 mm	175 mm	290 mm

C180/006
INSULATED SCREWDRIVER SET

1000V IEC 60900, with black phosphatized magnetic tip and polypropylene material oil resistant bi-color handle.

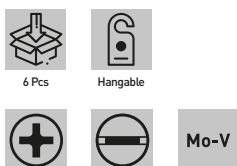

Sizes Slot (-) 0,6 x 3 x 100 mm, (-) 0,8 x 4 x 100 mm, (-) 1 x 5,5 x 125 mm
Cross (+) PH 0 x 3 x 60 mm, (+) PH 1 x 4,5 x 80 mm, (+) PH 2 x 6 x 100 mm

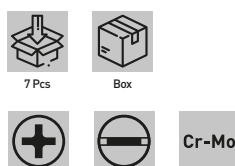
0355
ELECTRICIAN'S SCREWDRIVER

Sizes Slot (-) 0,4x2,5x85 mm, (-) 0,8x4,0x100 mm, (-) 1,0x5,5x125 mm, (-) 1,2x6,5x150 mm
Cross (+) PH 0x75 mm, (+) PH 1x100 mm, (+) PH 2x100 mm



0083

IMPACT DRIVER

Supplied in plastic box.



7 Pcs

Box

Steel

Satin

Dimensions	165 x 42 mm
Bits	6
Shank	5/16"

P882-

PH PRECISION SCREWDRIVER

With burnished magnetic tip, handle in two-component material with free end part to rotate for a perfect grip.



Cr-V

Phosphated

DIN

8764

Art.	Size	Pole length	Total length
P882/0150	PH 1	50 mm	140 mm
P882/1050	PH 0	50 mm	140 mm
P882/2050	PH 00	50 mm	140 mm

P886-

HEXAGONAL PRECISION SCREWDRIVER

With burnished magnetic tip, handle in two-component material with free end part to rotate for a perfect grip.



Cr-V

Phosphated

DIN

2936

Art.	Size	Pole length	Total length
P886/1350	1,3 mm	50 mm	140 mm
P886/1550	1,5 mm	50 mm	140 mm
P886/2050	2,0 mm	50 mm	140 mm
P886/2550	2,5 mm	50 mm	140 mm
P886/3050	3,0 mm	50 mm	140 mm

P883-

SLOT PRECISION SCREWDRIVER

With burnished magnetic tip, handle in two-component material with free end part to rotate for a perfect grip.



Cr-V

Phosphated

DIN

2380-1

Art.	Size	Pole length	Total length
P883/1250	1,2 mm	50 mm	140 mm
P883/1650	1,6 mm	50 mm	140 mm
P883/1850	1,8 mm	50 mm	140 mm
P883/2050	2,0 mm	50 mm	140 mm
P883/2450	2,4 mm	50 mm	140 mm
P883/3050	3,0 mm	50 mm	140 mm
P883/3550	3,5 mm	50 mm	140 mm
P883/4050	4,0 mm	50 mm	140 mm

P881-

TORX PRECISION SCREWDRIVER

With burnished magnetic tip, handle in two-component material with free end part to rotate for a perfect grip.



Cr-V

Phosphated

Art.	Size	Pole length	Total length
P881/0550	T5	50 mm	140 mm
P881/0650	T6	50 mm	140 mm
P881/0750	T7	50 mm	140 mm
P881/0850	T8	50 mm	140 mm
P881/0950	T9	50 mm	140 mm
P881/1050	T10	50 mm	140 mm
P881/1550	T15	50 mm	140 mm



P880/06S

PRECISION SCREWDRIVER SERIES

With burnished magnetic tip, handle in bicomponent material with free end part to rotate for a perfect grip.



Slotted 1.2 x 50 mm, 2.0 x 50 mm, 3.0 x 50 mm
Cross PH 00 x 50 mm, PH 0 x 50 mm, PH 1 x 50 mm

P881/06S

TORX PRECISION SCREWDRIVER SERIES

With burnished magnetic tip, handle in bicomponent material with free end part to rotate for a perfect grip.



Tee star T5 x 50 mm, T6 x 50 mm, T7 x 50 mm, T8 x 50 mm, T9 x 50 mm, T10

0207

DOUBLE HEAD SCREWDRIVER BIT SET

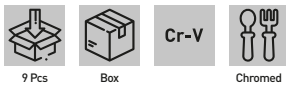

Blade length 110 mm
Handle length 170 mm

0829

PRECISION SCREWDRIVER AND SPANNER SET

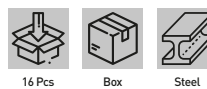

0082

PRECISION SCREWDRIVER SET



Slot 4 Pcs 1,4x20 mm - 2x23 mm - 2,4x24 mm - 3x27 mm
Cross 2 Pcs 2 Pcs PH 1x30 mm - PH 0x25 mm

0466/DM

SCREWDRIVERS MAGNETIZER/DEMAGNETIZER



Dimensions 52 x 50 x 28.5 mm

0888

L-SHAPED DRIVER

Bits inside the handle.

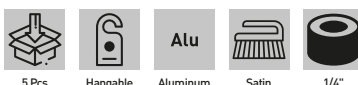

PIF1

FLEXIBLE BIT DRIVER



L	265 mm	L3	115 mm
L1	150 mm	A	10 mm
L2	9,5 mm	B	11,8 mm



0562

SHANK MAGNETIC HANDLE

Tricomponent handle made of highly elastic TPR resin and oil-resistant polypropylene material



Cr-V

Hangable



Chromed

1/4"

Length 200 mm

0304

1/4 SHANK MAGNETIC HANDLE



Hangable



Chromed

1/4"

0406

QUICK CHANGE 6 POINT BIT HOLDER



Cr-V

Expositor



Chromed

1/4"

Length 60 mm

0089

BIT SET



7 Pcs

Hangable

Phillips	1 - 2
Pozi-driv	1 - 2
Slotted	4 - 6 mm

0562N

SHANK MAGNETIC HANDLE

Tricomponent handle made of highly elastic TPR resin and oil-resistant polypropylene material



Cr-V

Hangable



Chromed

1/4"

Length 110 mm

0548

STUBBY RATCHET SCREWDRIVER

With one bit, to use for tight and loose in reduced space.



Hangable

Satin

72 teeth

1/4"

Dimensions ø 29 x 60 mm

0407

BIT HOLDER

Straight and 90°, easy to use in small spaces.



8 Pcs

Hangable

Length	105 mm
Phillips	1 - 2
Pozi-driv	1 - 2
Slotted	2 - 3 - 4 mm



0358
SCREWDRIVER BIT AND SOCKET SET



Bits	
Phillips	0 - 1 - 2 (x5 Pcs/Pcs) - 3
Pozi-driv	0 - 1 - 2 (x5 Pcs/Pcs) - 3
Slotted	3 - 4 - 4,5 - 5 - 5,5 - 6 - 6,5 - 7 - 8 mm
Spanner	4 - 6 - 8 - 10
Tee star	8 - 10 - 15 - 20 - 25 - 27 - 30 - 40 - 45
Triplay	1 - 2 - 3 - 4
Tamper proof tee star	8 - 10 - 15 - 20 - 25 - 27 - 30 - 35 - 40
Tee cross	6 - 8 - 10
Metric hex	1,5 - 2 - 2,5 - 3 - 4 - 5 - 5,5 - 6 - 8 mm
Square	0 - 1 - 2 - 3
Inch hex	1/16 - 5/64 - 3/32 - 7/64 - 1/8 - 9/64 - 5/32 - 3/16 - 7/32 -
Spline	M5 - M6 - M8
Hex tamper proof	2 - 2,5 - 3 - 4 - 5 - 6 - 5/64 - 3/32 - 7/64 - 1/8 - 9/64 - 5/32
Clutch	1 - 2 - 3
Male adapter 1/4" Dr. and 1/4" hex	25 mm



Male adapter 1/4" Dr. and 1/4" hex	50 mm
"Y" adapter	1 Pcs
Bit holder	1 Pcs
Magnetic bit holder	60 mm
Bit Holder	1 Pcs
Nut bit driver	4 - 5 - 6 - 7 - 8 - 9 - 10 - 11 - 12 - 13 - 5/32 - 3/13 - 7/32 -

0626L
LONG BIT SET

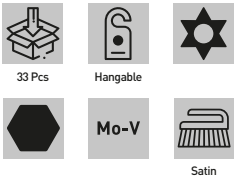
With magnetic holder.



Length	50 mm
Bits	
Tamper proof tee star	T7 - T8 - T10 - T15 - T20 - T25 - T30 - T35 - T40
Hex tamper proof	6 - 5 - 4 - 3 - 2,5 - 2 mm
Hex tamper proof	5/32 - 9/64 - 1/8 - 7/64 - 3/32 - 5/64
Spanner	4 - 6 - 8 - 10
Tee cross	6 - 8 - 10
Tri-wing	1 - 2 - 3 - 4

0626
BIT SET

With magnetic holder.



Bits	
Tee star	T7 - T8 - T10 - T15 - T20 - T25 - T30 - T35 - T40
Hexagonal	
Metric	6 - 5 - 4 - 3 - 2,5 - 2 mm
Inch	5/32 - 9/64 - 1/8 - 7/64 - 3/32 - 5/64
Spanner	4 - 6 - 8 - 10
Tee cross	6 - 8 - 10
Tri-wing	1 - 2 - 3 - 4

PI063
MULTIFUNCTION REPAIR TOOL KIT

62 pieces kit with magnetic revolving handle for precision repair of your tools, including smartphones, watches and appliances. The magnetic tray and the click-clack function allow to keep the bits organized without losing them.

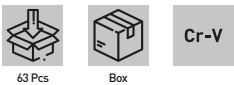

Magnetic bit holder	1
Phillips	PH00000 - PH0000 - PH000 - PH00 - PH0 - PH1 - PH2
Slotted	1.0 - 1.3 - 1.5 - 2.0 - 2.5 - 3.0 - 4.0
Hexagonal	0.7 - 0.9 - 1.3 - 1.5 - 2.0 - 2.5 - 3.0 - 3.5 - 4.0
Pozi-driv	PZ000 - PZ00 - PZ0 - PZ1
Square	0 - 1 - 2
"Y" adapter	Y0.6 - Y1.5 - Y2.3 - Y3.0
Pentagram	0.8 - 1.2 - 1.5 - 2.0
Triangle	2.0 - 2.3 - 3.0
U Type	U2.3 - U2.6
G	G3.8 - G4.5
M	M2.5 - M3.0 - M4.0
MID	
ICS	





0732

HEX BIT SET

Composed of 30 bit, 1 bit adapter and 1 bit holder.

NEW



Socket	25 mm
Magnetic bit holder	1
Slotted	3 - 4 - 5,5 - 7 mm
Hexagonal	3 - 4 - 5 - 6
Phillips	PH1 - PH2 - PH3 - PH4
Pozi-driv	PZ1 - PZ2 - PZ3 - PZ4
Tee star	T10 - T15 - T20 - T25 - T30 - T35 - T40
Tamper proof tee star	T10 - T15 - T20 - T25 - T30 - T35 - T40

0403

HEX BIT AND SOCKET SET

Composed of 6 sockets, 1 socket adapter and 1 ratchet screwdriver bit holder



Ratchet bit handle	1
Magnetic bit holder	1
Socket	25 mm
Socket	5 - 6 - 7 - 8 - 9 - 10 mm
Slotted	3 - 4 - 5 - 6 - 7 mm
Phillips	0 - 1 - 2 - 3
Pozi-driv	0 - 1 - 2 - 3
Square bits	S0 - S1 - S2 - S3

0404

HEX BIT AND SOCKET SET

With nichel coated bits made of S2 steel, sockets made of CR-V steel and quick change bit holder.



Socket	25 mm
Magnetic bit holder	1
Socket holder extension	1
Socket	5 - 6 - 7 - 8 - 9 - 10 - 11 - 12 mm
Slotted	3 - 4 - 5 - 5,5 - 6 - 7 mm
Phillips	0 - 1 - 2 - 3
Pozi-driv	0 - 1 - 2 - 3
Square bits	S0 - S1 - S2 - S3
Tee star	T10 - T15 - T20 - T25 - T30 - T40

0402

HEX BIT SET

Made of s2 steel and nichel coated, composed of 40 bits and 1 72t ratchet handle.

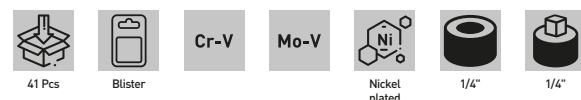

Shank	1/4"
Slotted	3 - 4 - 5 - 5,5 - 6 - 7 mm
Phillips	2 x 0 - 2 x 1 - 2 x 2 - 2 x 3
Pozi-driv	2 x 0 - 2 x 1 - 2 x 2 - 2 x 3
Square bits	S0 - S1 - S2 - S3
Tee star	T10 - T15 - T20 - T25 - T27 - T30 - T40
Hexagonal	2 - 2,5 - 3 - 4 - 5 - 5,5 - 6 mm



0104

SOCKET SET

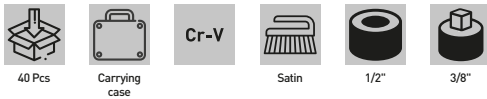

1 Socket bit 1/2"	10 mm
1 Socket bit 3/8"	10 mm
7 Hex bits 4-5-6-7-8-10-12 mm	30 mm
7 Hex bits 4-5-6-7-8-10-12 mm	75 mm
5 Bits "XZN" 5-6-8-10-12 mm	30 mm
5 Bits "XZN" 5-6-8-10-12 mm	75 mm
Bits TORX T20-T25-T30-T40-T45-T50-T55	30 mm
Bits TORX T20-T25-T30-T40-T45-T50-T55	75 mm

0277

HEX BIT AND SOCKET SET

With bit holder and ratchet handle.

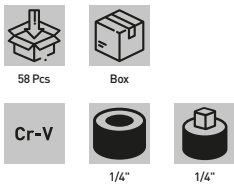

Bits	25 mm
Phillips (25 mm)	1 - 2 - 3
Pozi-driv	1 - 2 - 3
Slotted	3,5 - 4,5 - 5,5 - 6,5 mm
Spanner	4 - 6 - 8
Tee star	10 - 15 - 20 - 25 - 27 - 30 - 40
Tri-wing	1 - 2 - 3 - 4
Tee cross	6 - 8 - 10
Hexagonal	2 - 3 - 4 - 5 - 6 - 8 mm
Square	1 - 2 - 3
Spline	5 - 6 - 8
Clutch	1 - 2 - 3
Hex. sockets	5 - 6 - 7 - 8 - 10 mm
Hex. sockets	3/16 - 1/4 - 9/32 - 5/16 - 3/8
Socket	1/4"
"Y" adapter	1
Socket	1
Magnetic bit holder	1
Bit Holder	1
Ratchet handle	1/4"

0640

BIT SET

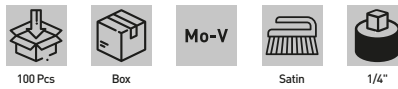

Bits	
Phillips	0 - 1 - 2 (x5 Pcs/Pcs) - 3
Pozi-driv	0 - 1 - 2 (x5 Pcs/Pcs) - 3
Slotted	3 - 4 - 4,5 - 5 - 5,5 - 6 - 6,5 - 7 - 8 mm
Spanner	4 - 6 - 8 - 10
Tee star	8 - 10 - 15 - 20 - 25 - 27 - 30 - 40 - 45
Tripley	1 - 2 - 3 - 4
Tamper proof tee star	8 - 10 - 15 - 20 - 25 - 27 - 30 - 35 - 40
Tee cross	6 - 8 - 10
Metric hex	1,5 - 2 - 2,5 - 3 - 4 - 5 - 5,5 - 6 - 8 mm
Square	0 - 1 - 2 - 3
Inch hex	1/16 - 5/64 - 3/32 - 7/64 - 1/8 - 9/64 - 5/32 - 3/16 - 7/32 - 1/4
Spline	M5 - M6 - M8
Hex tamper proof	2 - 2,5 - 3 - 4 - 5 - 6 - 5/64 - 3/32 - 7/64 - 1/8 - 9/64 - 5/32
Clutch	1 - 2 - 3



**IS25-ESX****HEXAGONAL BITS**

Mo-V



Art.	Size	Length	Pack
IS25/ES2	2 mm	25 mm	10
IS25/ES25	2.5 mm	25 mm	10
IS25/ES3	3 mm	25 mm	10
IS25/ES4	4 mm	25 mm	10
IS25/ES5	5 mm	25 mm	10
IS25/ES6	6 mm	25 mm	10
IS25/ES8	8 mm	25 mm	10
IS25/ES10	10 mm	25 mm	10

IS25-PHXAS**CROSS BITS PH ANTI SLIP**

Mo-V



Art.	Size	Length	Pack
IS25/PH1AS	PH 1	25 mm	10
IS25/PH2AS	PH 2	25 mm	10
IS25/PH3AS	PH 3	25 mm	10

IS25-PZXAS**CROSS BITS PZ ANTI SLIP**

Mo-V



Art.	Size	Length	Pack
IS25/PZ1AS	PZ 1	25 mm	10
IS25/PZ2AS	PZ 2	25 mm	10
IS25/PZ3AS	PZ 3	25 mm	10

IS25-TXX**TORX BITS**

Mo-V



Art.	Size	Length	Pack
IS25/TX10	T10	25 mm	10
IS25/TX15	T15	25 mm	10
IS25/TX20	T20	25 mm	10
IS25/TX25	T25	25 mm	10
IS25/TX30	T30	25 mm	10
IS25/TX35	T35	25 mm	10
IS25/TX40	T40	25 mm	10
IS25/TX45	T45	25 mm	10
IS25/TX50	T50	25 mm	10
IS25/TX55	T55	25 mm	10

IS25-PHX**CROSS BITS PH**

Mo-V



Art.	Size	Length	Pack
IS25/PH0	PH 0	25 mm	20
IS25/PH1	PH 1	25 mm	20
IS25/PH2	PH 2	25 mm	20
IS25/PH3	PH 3	25 mm	20

IS25-PZX**CROSS BITS PZ**

Mo-V



Art.	Size	Length	Pack
IS25/PZ1	PZ 1	25 mm	20
IS25/PZ2	PZ 2	25 mm	20
IS25/PZ3	PZ 3	25 mm	20

IS25-TGX**SLOTTED BITS**

Mo-V



Art.	Size	Length	Pack
IS25/TG3	3 x 0.5 mm	25 mm	10
IS25/TG4	4 x 0.8 mm	25 mm	10
IS25/TG5.5	5.5 x 0.8 mm	25 mm	10
IS25/TG6	6 x 1 mm	25 mm	10
IS25/TG8	8 x 1.2 mm	25 mm	10

IS50-ESX**HEXAGONAL BITS**

Turn-down body.



Mo-V



Art.	Size	Length	Pack
IS50/ES2	2 mm	50 mm	5
IS50/ES25	2.5 mm	50 mm	5
IS50/ES3	3 mm	50 mm	5
IS50/ES4	4 mm	50 mm	5
IS50/ES5	5 mm	50 mm	5
IS50/ES6	6 mm	50 mm	5
IS50/ES8	8 mm	50 mm	5
IS50/ES10	10 mm	50 mm	5

IS50-PHX
CROSS BITS PH

With turn-down body.

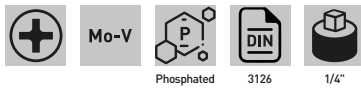

Art.	Size	Length	Pack
IS50/PH1	PH 1	50 mm	10
IS50/PH2	PH 2	50 mm	10
IS50/PH3	PH 3	50 mm	10

IS50-PZX
CROSS BITS PZ

With turn-down body.

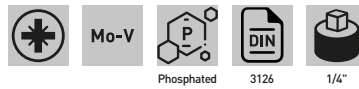

Art.	Size	Length	Pack
IS50/PZ1	PZ 1	50 mm	10
IS50/PZ2	PZ 2	50 mm	10
IS50/PZ3	PZ 3	50 mm	10

IS50-TGX
SLOTTED BITS

With turn-down body.

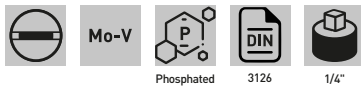

Art.	Size	Length	Pack
IS50/TG3	3 x 0.5 mm	50 mm	5
IS50/TG4	4 x 0.8 mm	50 mm	5
IS50/TG5.5	5.5 x 0.8 mm	50 mm	5
IS50/TG6	6 x 1 mm	50 mm	5
IS50/TG8	8 x 1.2 mm	50 mm	5

IS50-TXX
TORX BITS

With turn-down body.

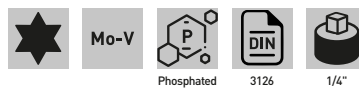

Art.	Size	Length	Pack
IS50/TX10	T10	50 mm	5
IS50/TX15	T15	50 mm	5
IS50/TX20	T20	50 mm	5
IS50/TX25	T25	50 mm	5
IS50/TX30	T30	50 mm	5
IS50/TX35	T35	50 mm	5
IS50/TX40	T40	50 mm	5

S018
HAND RIVETER SET

Rivets	50 x ø2,4 mm - 50 x ø3,2 mm - 50 x ø4,0 mm - 50 x ø4,8 mm
Nut rivets	50 x M3 - 50 x M4 - 25 x M5 - 25 x M6 - 20 x M8
Description	330 x 170 x 150 mm



0455

DOUBLE HAND NUT RIVETER

Long levers for effortless work, with 7 nosepieces.



Nosepieces M3 - M4 - M5 - M6 - M8 - M10 - M12
Length 400 mm

0469

HAND NUT RIVETER

With 4 nosepieces. Ergonomic handles.

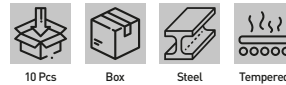

Nosepieces M3 - M4 - M5 - M6
Length 200 mm

0453

DOUBLE HAND RIVETER

Long levers for effortless work, even with 6.4 mm rivets. Plastic reservoir for sheared nail recovery.



Rivets Ø 3,2 - 4,0 - 4,8 - 6,0 - 6,4 mm
Length 400 mm

0454

DOUBLE HAND RIVETER WITH ROTATING HEAD

Long levers for effortless work, even with 6.4 mm rivets. Plastic reservoir for sheared nail recovery. With 4-position rotating head.

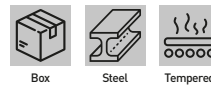

Rivets Ø 3,2 - 4,0 - 4,8 - 6,4 mm
Length 400 mm

0470

HAND RIVETER WITH MULTI-SIDES BLOCKER

With rotating head - 4 positions.



Rivets 2,4 mm - 3,2 mm - 4,0 mm - 4,8 mm

0789

HAND RIVETER



Rivets 2,4 mm - 3,2 mm - 4,0 mm - 4,8 mm
Length 255 mm



0872/P

DOUBLE JOINT LONG PLIER SET

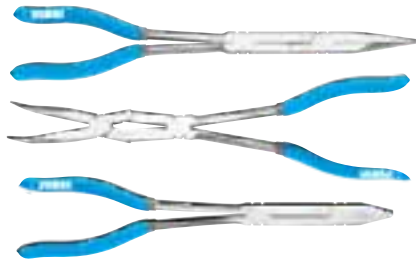

Length	335 mm
Thickness	10 mm

0872/PDD

DOUBLE X LONG REACH PLIER LONG NOSE

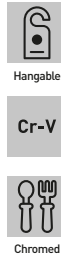

Length	335 mm
Thickness	10 mm

0872/PCD

DOUBLE X LONG REACH PLIER LONG BENT NOSE 45°

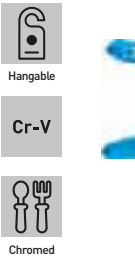

Length	335 mm
Thickness	10 mm

0872/OPD

DOUBLE X LONG REACH PLIER

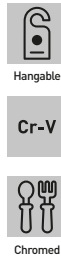

Length	335 mm
Thickness	10 mm

0873-U

COMBINATION PLIERS

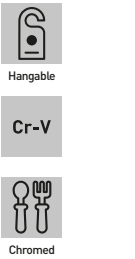

Art.	Length	Thickness
0873/U6	160 mm	11 mm
0873/U7	180 mm	10,5 mm
0873/U8	200 mm	12 mm

0873-BD

LONG NOSE PLIERS

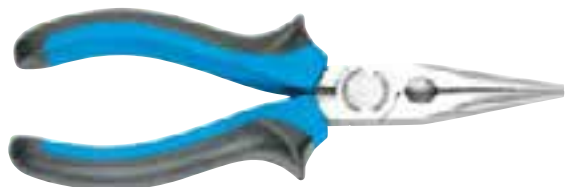

Art.	Length	Thickness
0873/BD6	160 mm	9 mm
0873/BD8	200 mm	10 mm

0873-BC

BENT NOSE PLIERS 45°

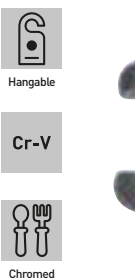

Art.	Length	Thickness
0873/BC6	160 mm	9 mm
0873/BC8	200 mm	10 mm

0873/TL

DIAGONAL SIDE CUTTING NIPPERS



Length	160 mm
Thickness	9 mm



0873/TF

END CUTTING NIPPERS



Blister



Cr-V



Chromed



Length 160 mm
Thickness 11 mm

0020/1

EXTRA LONG NOSE MINI PLIERS



Blister



Steel



Chromed



Length 150 mm

0020/2

BENT NOSE MINI PLIERS



Blister



Steel



Chromed



Length 125 mm

0020/3

FLAT NOSE MINI PLIERS



Blister



Steel



Chromed



Length 125 mm

0020/4

LONG NOSE MINI PLIERS



Blister



Steel



Chromed



Length 125 mm

0020/5

END CUTTING MINI NIPPERS



Blister



Steel



Chromed



Length 110 mm

0020/6

DIAGONAL SIDE CUTTING MINI NIPPERS



Blister



Steel



Chromed



Length 110 mm

0020

FINE POLISHED MINI PLIERS SET



5 Pcs



Blister



Steel



Bakelite



Chromed

Length 110 ÷ 125 mm



08X

COMBINATION PLIERS



Art.	Length	Thickness
0810	160 mm	11 mm
0811	180 mm	11 mm
0850	200 mm	13 mm

0812

LONG NOSE PLIERS



Art.	Length	Thickness
	160 mm	10 mm

0813

BENT NOSE PLIERS 45°



Length	160 mm
Thickness	10 mm

0814

DIAGONAL SIDE CUTTING NIPPERS



Length	160 mm
Thickness	10 mm

0841

RATCHET CRIMPING TOOL

With release lever.



For insulated terminals	Ø 0,8 ÷ 3,5 mm / 0,25 ÷ 6 mm ² AWG 22-10
Length	230 mm
Thickness	12 mm

0843

RATCHET CRIMPING TOOL

With release lever.



For barrel open terminals	Ø 1 ÷ 3,5 mm / 0,5 ÷ 6 mm ² AWG 20-10
Length	230 mm
Thickness	12 mm

0847

CRIMPING PLIERS FOR END SLEEVES TERMINALS

With release lever.

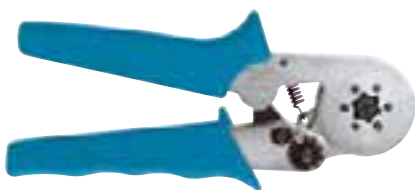

Terminals	0,25 ÷ 6 mm ² AWG 23-10
Length	175 mm
Thickness	12 mm

0628

MODULAR PLUG CRIMPING TOOL

With release knob.



Electric plugs	RJ-11 (6P4C); RJ-12 (6P6C); RJ-45 (8P8C)
----------------	--



0826

CRIMPING PLIER AND WIRE STRIPPER

Car and computer crimping plier with wire stripper for thin wire.



Length	215 mm
Terminals	AWG 30-26 - AWG 24-20 - AWG 18-14
Cutting capacity	∅ 0,25 - 0,3 - 0,4 - 0,5 - 0,65 - 0,8 - 1,0 mm AWG30 - AWG28 - AWG26 - AWG24 - AWG22 - AWG20 - AWG18

0122

UNIVERSAL CRIMPING PLIER SET

With insulated terminals.

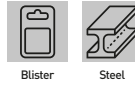

Length	220 mm
--------	--------

024XE

CIRCLIP PLIERS

External straight nose.



Art.	Circlips	Length
0246	∅ 19 ÷ 60 mm	185 mm
0636	∅ 10 ÷ 25 mm	160 mm
0674	∅ 3 ÷ 10 mm	150 mm
0676	∅ 32 ÷ 80 mm	225 mm

024XI

CIRCLIP PLIERS

Internal straight nose.



Art.	Circlips	Length
0248	∅ 19 ÷ 60 mm	175 mm
0638	∅ 8 ÷ 25 mm	150 mm
0619	∅ 3 ÷ 10 mm	135 mm
0631	∅ 32 ÷ 80 mm	225 mm

063XE

CIRCLIP PLIERS

External curved nose.



Art.	Circlips	Length
0247	∅ 19 ÷ 60 mm	175 mm
0637	∅ 10 ÷ 25 mm	150 mm
0108	∅ 3 ÷ 10 mm	135 mm
0324	∅ 32 ÷ 80 mm	215 mm

063XI

CIRCLIP PLIERS

Internal curved nose.



Art.	Circlips	Length
0249	∅ 19 ÷ 60 mm	165 mm
0639	∅ 8 ÷ 25 mm	150 mm
0340	∅ 3 ÷ 10 mm	135 mm
0364	∅ 32 ÷ 80 mm	215 mm

0136

NYLON CLAMP SET

Automotive hose.



Length	158 - 185 - 254 mm
Hose diameter	10 - 15 - 24 mm

0603

AUTO REPAIRING PLIERS SET FOR CARS ZIP TIES





0118

WATER PUMP PLIERS

6 positions.



HANGABLE STEEL

Length 240 mm

0834-

TOWER PINCERS



HANGABLE STEEL 9242

Art.	Length
0834	220 mm
0834/200	200 mm
0834/250	250 mm
0834/280	280 mm

0121

LOCKING L-GRIP CLAMP



BOX STEEL SATIN

Length 230 mm
Adjustable 0 ÷ 155 mm

0119

ADJUSTABLE LOCK WRENCH

NEW



BOX STEEL SATIN

Art.	Length
0119/5	130 mm
0119/7	180 mm
0119	220 mm

0831-

WATER PUMP PLIERS

7 positions.

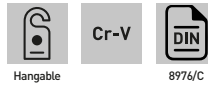

HANGABLE Cr-V 8976/C

Art.	Length
0831/175	175 mm
0831/250	250 mm
0831/300	300 mm

0206

CARPENTER PINCER



HANGABLE STEEL

Length 200 mm

0120

4 POSITIONS ADJUSTABLE LOCK WRENCH

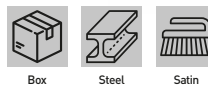

BOX STEEL SATIN

Length 230 mm
Opening 18 - 39 - 43 mm

0379

FOUR JAWS ADJUSTABLE LOCK WRENCH

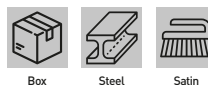

BOX STEEL SATIN

Length 225 mm



0368-

AUTOMATIC LOCK WRENCH



Cr-V



Box

Satin

Art.	Length
0368/7	160 mm
0368/10	230 mm

0370-

LONG NOSE AUTOMATIC LOCK WRENCH



Cr-V



Box

Satin

Art.	Length
0370/8	200 mm
0370/11	275 mm

0373-

"C" NOSE AUTOMATIC LOCK WRENCH



Cr-V



Box

Satin

Art.	Length	Opening
0373/9	210 mm	65 mm
0373/11	300 mm	95 mm

0130-

HEAVY DUTY PIPE WRENCH



Cr-V

Art.	Dimensions	Max Opening
0130/350	350 mm - 14"	50 mm
0130/600	600 mm - 24"	90 mm

0225-

45° BENT NOSE PIPE WRENCH



Cr-V

Art.	Dimensions	Max Opening
0225/340	340 mm - 1"	46 mm
0225/440	440 mm - 1,5"	62 mm
0225/580	580 mm - 2"	72 mm
0225/700	700 mm - 3"	100 mm

0227-

90° BENT NOSE PIPE WRENCH



Cr-V

Art.	Dimensions	Max Opening
0227/340	330 mm - 1" mm	38 mm
0227/440	415 mm - 1,5" mm	52 mm
0227/580	580 mm - 2" mm	75 mm
0227/700	700 mm - 3" mm	100 mm

0511

SLEDGE HAMMER

With safety fiberglass plastic handle with black rubber grip.



Glass fiber

Length	820 mm
Head weight	3,50 kg
Net weight	4,45 kg

0780

CLAW HAMMER

With safety fiberglass plastic handle with black rubber grip.



Glass fiber

Net weight	500 g
------------	-------

0154-

MACHINIST'S HAMMER GERMAN TYPE



Wood



1041

Art.	Net weight
0154/100DIN	100 g
0154/200DIN	200 g
0154/300DIN	300 g
0154/400DIN	400 g
0154/500DIN	500 g
0154/600DIN	600 g
0154/800DIN	800 g
0154/1000DIN	1000 g
0154/1500DIN	1500 g
0154/2000DIN	2000 g

0781

STONING HAMMER

With safety fiberglass plastic handle with black rubber grip.



Glass fiber



6475

Length	260 mm
Net weight	1000 g

0514-

MACHINIST'S HAMMER GERMAN TYPE

With safety fiberglass plastic handle with black rubber grip.



Glass fiber



1041

Art.	Net weight
0514/200	200 g
0514/300	300 g
0514/400	400 g
0514/500	500 g
0514/1000	1000 g

0153-

STONING HAMMER



Wood



1041



Wood



6475

Art.	Net weight
0153/800DIN	800 g
0153/1000DIN	1000 g
0153/1250DIN	1250 g
0153/1500DIN	1500 g



0169-

CLAW HAMMER ITALIAN TYPE

Magnetic.



Wood

Art.	Net weight
0169/300	300 g
0169/400	400 g

0216/400

CHIPPING HAMMER

With wooden handle.



Wood

Handle length	380 mm
Net weight	400 g

0239/400

CHIPPING HAMMER

With fiberglass plastic handle with black rubber grip.



Glass fiber

Handle length	380 mm
Net weight	400 g

0148/500

RUBBER MALLET



Wood

Head	ø 65 mm
Net weight	500 g

0243-

TWO WAY MALLET



Glass fiber

Art.	Head	Net weight
0243/30	ø 30 mm	350 g
0243/40	ø 40 mm	500 g

0794-

TWO WAY RUBBER MALLET

Equipped of fiberglass handle.



Glass fiber

Art.	Head	Net weight
0794/350	ø 55 mm	350 g
0794/450	ø 58 mm	500 g

0808-

MALLET

Aluminium with anatomic handle and polyethylene heads.



Wood

Art.	Head	Net weight
0808/35	ø 35 mm	350 g
0808/60	ø 60 mm	800 g

033X

DEAD BLOW RUBBER MALLET



Art.	Head	Net weight
0336	ø 45 mm	500 g
0337	ø 50 mm	900 g

0839-

DEAD BLOW MALLET

Nylon, spare part head.



Art.	Head	Net weight
0839/40	ø 40 mm	750 g
0839/50	ø 50 mm	1000 g
0839/60	ø 60 mm	1500 g

0839-XT

SPARE PART HEAD

For dead blow mallet 0839-.



Art.	Head
0839/40T	ø 40 mm
0839/50T	ø 50 mm
0839/60T	ø 60 mm

072X

DEAD BLOW NYLON MALLET

With monoblock body made of shock resistant aluminium alloy. Anatomic handle made of non-sliding wood. Internal mass composed of lead balls. Changeable heads made of non-deformable nylon.



Art.	Head	Net weight
0726	ø 40 mm	550 g
0727	ø 50 mm	900 g
0728	ø 60 mm	1100 g

073X

SPARE PART HEAD

For dead blow nylon mallet 072x.



Art.	Head	Pack
0729	ø 40 mm	2
0730	ø 50 mm	2
0731	ø 60 mm	2

G009

SAFE SPRING HOOK

To put in safety tools when working on ladders or scaffolds.



INOX

Blister



Capacity	5 kg
Length	430 ÷ 1600 mm

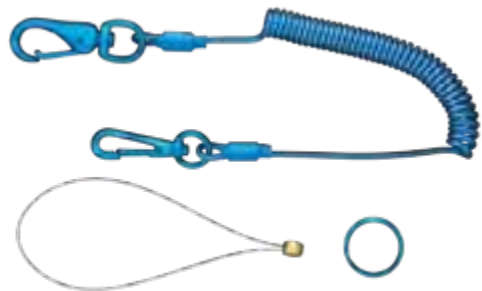



B006-

CENTER PUNCH

With octagonal body.



Cr-Mo



7250

Art.	Sizes	Length
B006/4	4 mm	120 mm
B006/5	5 mm	150 mm

S022-

CHISEL FOR METAL



Cr-Mo

Hangable

Art.	Dimensions	Length
S022/18	18 mm	150 mm
S022/21	21 mm	200 mm
S022/25	25 mm	250 mm
S022/26	26 mm	240 mm

C015

DRIFT PIN SET

With octagonal body and hand guard.



7 Pcs



Hangable



Cr-Mo



Chromed

Sizes \varnothing 2 - 3 - 4 - 5 - 6 - 7 - 8 mm

0127

MECHANIC CHISEL, PIN PUNCH AND CENTER PUNCH SET WITH PLASTIC HOLDER



6 Pcs



Blister



Cr-V

Length 120 - 150 mm

C012-

DRIFT PIN

With octagonal body.



Cr-Mo

Hangable



Art.	Dimensions	Length
C012/02	\varnothing 2 mm	150 mm
C012/03	\varnothing 3 mm	150 mm
C012/04	\varnothing 4 mm	150 mm
C012/05	\varnothing 5 mm	150 mm
C012/06	\varnothing 6 mm	150 mm
C012/08	\varnothing 8 mm	150 mm

C015-

DRIFT PIN

With octagonal body and hand guard.



Cr-Mo

Hangable



Chromed



Art.	Size	Length
C015/2	\varnothing 2 x 8 mm	140 mm
C015/3	\varnothing 3 x 8 mm	150 mm
C015/4	\varnothing 4 x 10 mm	180 mm
C015/5	\varnothing 5 x 10 mm	220 mm
C015/6	\varnothing 6 x 12 mm	210 mm
C015/7	\varnothing 7 x 12 mm	210 mm

0126

DRIFT PIN SET WITH PLASTIC HOLDER



6 Pcs



Blister

Cr-V

Dimensions \varnothing 3-4-5-6-8-10 mm
Length 150 mm

0396

CHISEL SET FOR METAL



3 Pcs



Hangable

Cr-V

Dimensions 10 x 8 x 140 mm, 13 x 9,5 x 150 mm, 16 x 12 x 170 mm



0381

AUTOMATIC CENTER PUNCH

With spring.



Length 125 mm

0733

NEW

AUTOMATIC CENTER PUNCH

Spring-loaded. Possibility of adjusting the punching depth.



Length 125 mm

0734-

NEW

HOLE MARKERS

For centring within existing bores, the spring-loaded, conical front provides accurate centring.

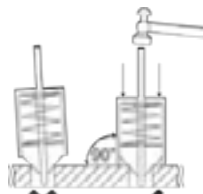
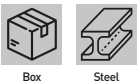

Art.	Length	Hole diameter
0734/1	100 mm	Ø5 ÷ Ø15 mm
0734/2	82 mm	Ø5 ÷ Ø30 mm

0391

MECHANIC CHISEL, PIN PUNCH AND CENTER PUNCH SET WITH HAND GUARD



Chisel	10 x 135 mm, 13 x 150 mm, 16 x 160 mm
Center punches	04 x 130 mm
Solid punch	03 x 120 mm
Pin punch	03 x 120 mm

0152

STONING CHISEL SET WITH HAND GUARD

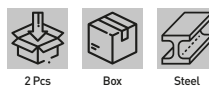

Dimensions 16 x 250 mm

0258

FLAT POINT COLD CHISEL WITH HAND GUARD



Dimensions 16 x 300 mm

0259

POINT COLD CHISEL WITH HAND GUARD



Dimensions 16 x 300 mm



0300

WOOD CHISEL SET



Hardness HRC 58-60
Dimensions 10-16-20-25 mm



0301-

WOOD CHISEL

Hardness HRC 58-60.



Art.	Dimensions
0301/06	6 mm
0301/10	10 mm
0301/16	16 mm
0301/20	18.5 mm
0301/24	25 mm



0168

WOOD CHISEL SET



Hardness HRC 58-60
Sizes 240 x 6-10-16-20-24 mm



0306

CARVING CHISEL SET

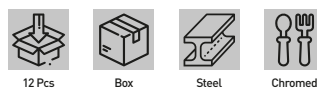

Hardness HRC 58-60
Length 215 mm



0162

WOOD CHISEL SET FOR LATHE



Hardness HRC 58-60
Total length 370 mm



0166

IRON PLANER FOR WOOD



Planner length 225 mm
Blade width 50 mm





0519

WOOD RASP SET WITH PLASTIC HANDLE



Dimensions 200 mm - 8"



0160

FILE SET FOR METAL WITH ANATOMIC HANDLE



Dimensions 200 mm - 8"



0219

NEEDLE FILE SET



Total length 180 mm



0214

ROUND HANDLE NEEDLE FILE SET



Dimensions Ø 3 x 140 mm



L011

BENT NOSE DIAMOND NEEDLE FILE SET



Length 140 mm



L012

DIAMOND NEEDLE FILE SET



Length 180 mm



L013

DIAMOND NEEDLE FILE SET



Length 140 mm



L012/PIA

DIAMOND FLAT FILE

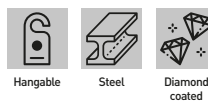

Length 180 mm





0737-

STEEL FILE

Rectangular shape, with ergonomic plastic handle.



Art.	Slotted	Dimensions	Pack
0737/150T2	Half cut	150 mm - 6"	10
0737/150T3	Smooth cut	150 mm - 6"	10
0737/200T2	Half cut	200 mm - 8"	10
0737/200T3	Smooth cut	200 mm - 8"	10
0737/250T2	Half cut	250 mm - 10"	10
0737/250T3	Smooth cut	250 mm - 10"	10

0739-

STEEL FILE

Half round shape. With ergonomic plastic handle.



Art.	Slotted	Dimensions	Pack
0739/150T2	Half cut	150 mm - 6"	10
0739/150T3	Smooth cut	150 mm - 6"	10
0739/200T2	Half cut	200 mm - 8"	10
0739/200T3	Smooth cut	200 mm - 8"	10
0739/250T2	Half cut	250 mm - 10"	10
0739/250T3	Smooth cut	250 mm - 10"	10

0741-

STEEL FILE

Squared shape. With ergonomic plastic handle.



Art.	Slotted	Dimensions	Pack
0741/150T2	Half cut	150 mm - 6"	10
0741/150T3	Smooth cut	150 mm - 6"	10
0741/200T2	Half cut	200 mm - 8"	10
0741/200T3	Smooth cut	200 mm - 8"	10
0741/250T2	Half cut	250 mm - 10"	10
0741/250T3	Smooth cut	250 mm - 10"	10

0738-

STEEL FILE

Triangular shape. With ergonomic plastic handle.



Art.	Slotted	Dimensions	Pack
0738/150T2	Half cut	150 mm - 6"	10
0738/150T3	Smooth cut	150 mm - 6"	10
0738/200T2	Half cut	200 mm - 8"	10
0738/200T3	Smooth cut	200 mm - 8"	10
0738/250T2	Half cut	250 mm - 10"	10
0738/250T3	Smooth cut	250 mm - 10"	10

0740-

STEEL FILE

Round shape. With ergonomic plastic handle.



Art.	Slotted	Dimensions	Pack
0740/150T2	Half cut	150 mm - 6"	10
0740/150T3	Smooth cut	150 mm - 6"	10
0740/200T2	Half cut	200 mm - 8"	10
0740/200T3	Smooth cut	200 mm - 8"	10
0740/250T2	Half cut	250 mm - 10"	10
0740/250T3	Smooth cut	250 mm - 10"	10

0742-

ANATOMIC PLASTIC FILE HANDLE



Art.	For file	Pack
0742/4	100 mm - 150 mm / 4" - 6"	12
0742/6	150 mm - 250 mm / 6" - 10"	12
0742/10	250 mm - 400 mm / 10" - 16"	12



0202

PRY BAR SET GO THROUGH TYPE



4 Pcs



Blister



Steel

Dimensions 230 mm/9" - 300 mm/12" - 450 mm/18" - 590 mm/24"

0192

HEAVY DUTY PRY BAR SET

1 Pc straight 910 mm/36", 1 Pc bent 45° 910 mm/36", 1 Pc bent 60° 610 mm/24", 1 Pc bent 90° 610 mm/24".



4 Pcs



Carrying case

Cr-V

L007

MOTORCYCLE TYRE LEVER



Box



Steel



Satin

Dimensions 215 x 16 X 5 mm

0320

WRECKING BAR



Steel

Total length 600 mm
Hexagon 15,6 mm

0198

POINTED PRY BAR

Pointed pry bar.

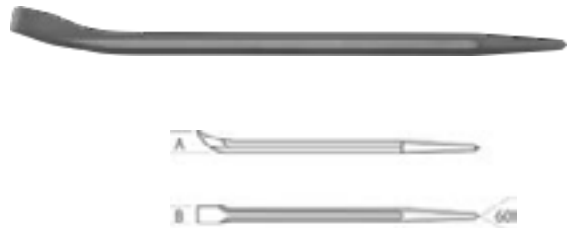

Steel

Length 400 mm
A 30 mm
B 23 mm
Pack 5

0267

TYRE LEVER



Box



Steel



Satin

Dimensions 510 x 26 x 9 mm





0623

SNAP-OFF UTILITY KNIFE, BLADES INCLUDED

With automatic loading of the blade

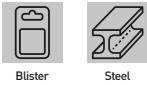

Standard blades 3
Blade width 18 mm

0627

SNAP-OFF UTILITY KNIFE BLADES INCLUDED

With automatic loading of the blade



Standard blades 5
Blade width 9 mm

0617

AUTOMATIC SNAP-OFF UTILITY KNIFE BLADES INCLUDED

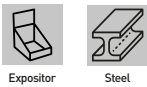

Standard blades 3
Blade width 18 mm

0613

STAINLESS STEEL SNAP-OFF UTILITY KNIFE

ISO 9001.



Standard blades 3
Blade width 9 mm

0096

SNAP-OFF UTILITY KNIFE, BLADES INCLUDED

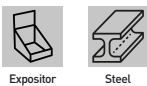

Standard blades 3
Blade width 18 mm

0612

STAINLESS STEEL SNAP-OFF UTILITY KNIFE



Standard blades 3
Blade width 9 mm



0611

STAINLESS STEEL SNAP-OFF UTILITY KNIFE

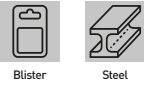

Standard blades 3
Blade width 9 mm

0035

SECURITY SNAP-OFF UTILITY KNIFE, BLADES INCLUDED



Standard blades 4
Trapezoidal blade 19 x 61 x 0,6 mm

0792

AUTOMATIC SNAP-OFF UTILITY KNIFE, BLADES INCLUDED

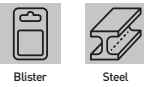

Standard blades 5
Blade width 25 mm

0696

FOLDABLE UTILITY KNIFE, BLADES INCLUDED



Standard blades 5
Blade width 20 mm

0095

SNAP-OFF KNIFE SET



0696/L

PAPER CUTTER BLADE SET



Trapezoidal blade 19 x 61 x 0,6 mm



0627/L

PAPER CUTTER BLADE SET



Blade width 9 mm





0096/L

PAPER CUTTER BLADE SET

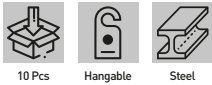

Blade width 18 mm



0792/L

PAPER CUTTER BLADE SET

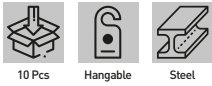

Blade width 25 mm



0420

DEBURRING TOOL WITH 1 BLADE



Length 120 mm
 Max. handle diameter 9,2 mm
 Blade E100 - Ø 3,2 mm
 Blade material HSS

0411

DEBURRING TOOL WITH 1 BLADE



Length 124 mm
 Max. handle diameter 29 mm
 Blade E100 - Ø 3,2 mm
 Blade material HSS

0415

DEBURRING TOOL WITH 2 BLADE



Length 125 mm
 Max. handle diameter 22 mm
 Blade E100 - E200 - Ø 3,2 mm
 Blade material HSS

S002

EXTENSIBLE DEBURRING TOOL WITH 3 BLADES

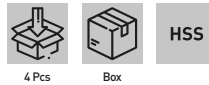

Blade Ø 3,2 mm
 Blade dimensions E100 - E200 - E300



0420/S

DEBURRING SET WITH BLADES

For internal and external deburring of hard and soft materials. Comfortable and practical equipped with clips to always carry them with you and have them available at the right time. With ergonomic handle and different colors to immediately identify the right deburrer for the right material: purple for aluminum, red for brass and cast iron, blue for steel and yellow for plastic



Length 120 mm
 Blade Ø 3.2 mm

S002/E100

HSS LONG SHANK BLADE SET

For internal and external deburring for long chips material like steel, aluminum, plastic materials.



S002/E200

HSS BIDIRECTIONAL BLADE SET

For internal and external deburring short chips material like brass and cast iron.



S002/E300

HSS BIDIRECTIONAL BLADE SET

For internal and external deburring for holes until 4 mm of thickness.



S005
DOUBLE DEBURRER WITH HSS DISK BLADE

For steel, aluminum, brass, copper and plastic sheets deburring max 10 mm.



Box

HSS
S005/R
DISK BLADE SET



4 Pcs



Box

HSS
0384
INNER-OUTER REAMER

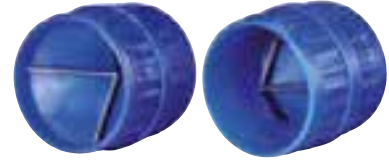
For copper and ferrous metals.



2 Pcs



Box

Plastic
Capacity

3 ÷ 32 mm 3/16" ÷ 1-1/2"

0647/25
PAINT SCRAPER WITH 25 MM CARBIDE BLADE THREE CUTTING EDGES

Blister

HM

Satin

0647/50
PAINT SCRAPER WITH 50 MM CARBIDE BLADE TWO CUTTING EDGES

Blister

HM

Satin

0647/65
PAINT SCRAPER WITH 65 MM CARBIDE BLADE TWO CUTTING EDGES

Blister

HM

Satin

0647/25L
2 PCS BLADE SET

2 Pcs



Blister

HM
0647/50L
2 PCS BLADE SET

2 Pcs



Blister

HM
0647/65L
2 PCS BLADE SET

2 Pcs



Blister

HM



0367

CARVING KNIFE SET

With 240 grit stone, 26 spare knives. For use on wood, polystyrene, EVA, foam.



Grindstone	1 - grana / grain 240
Precision screwdriver	1
Tweezers	1
Double color grip	4
Carving knife blades	26
Plastic case	1, ABS+TPR



0226

HACKSAW FRAME WITH ALUMINUM ALLOY HANDLE

With handle for small cut. Bi-metal hack saw blade and aluminum body.



Blade length 310 mm

0161

MINI HACKSAW WITH BLADE



Alu

Aluminum

Blade length 150 mm

0724/B

BI-METAL HACK SAW BLADE

ISO 2336-1.



Box

HSS

Sizes 300 x 12,7 x 0,62 mm x 24T - 12" x 1/2" x 0.025" x 24T
Pack 10

0869

HANDSAW FOR JOINER WITH TRIPLE DRESSED SHARPENING DIAMOND TYPE



Steel

Blade length 400 mm

0629

HACKSAW WITH BLADE

Bi-metal hack saw blade and aluminum body.



Blade length 300 mm

0327

BOW HANDSAW FOR WOOD



Steel

Blade length 530 mm / 21"

0159

HACKSAW BLADE

ISO 2336-1.



Box

Sizes 300 x 12,7 x 0,62 mm x 24T - 12" x 1/2" x 0.025" x 24T
Pack 100

0670
NIBBLER FOR POWER DRILL

Double head nibbler, with accessory for round and straight cutting purpose.



Box

HSS
TiN
0670/U
CUTTER HOLDERS

Cutting capacity

Iron plates	1,8 mm
Stainless steel plate	1,2 mm
Copper and aluminum plate	2,0 mm
Plastic materials	2,0 mm
Round speed	1500 - 3000 rpm
Collar	∅ 43,2 mm
Metal box	

0655/L
LEFT HAND AVIATION TIN SNIP

With serrated and hardened blade and ergonomic handles.



Blister

Cr-V

Chromed

Length	245 mm
Hardness	50 - 52 HRC

0655/S
STRAIGHT AVIATION TIN SNIP

With serrated and hardened blade and ergonomic handles.



Blister

Cr-V

Chromed

Length	245 mm
Hardness	50 - 52 HRC

0655/R
RIGHT HAND AVIATION TIN SNIP

With serrated and hardened blade and ergonomic handles.



Blister

Cr-V

Chromed

Length	245 mm
Hardness	50 - 52 HRC

0818/250
TINMAN'S SNIPS

Blister



Steel



Satin

Length	265 mm
--------	--------

0699/240
INOX SCISSORS

With nylon handle.



Blister

INOX

Satin

Length	240 mm
--------	--------

0672
ELECTRICIAN SCISSORS

With serrated blade, and ergonomic handle in abs material.



Blister

INOX

Satin

Length	5" 1/2 - 140 mm
--------	-----------------



0672/B

ELECTRICIAN SCISSORS

With serrated blade and, bicolor non-slip ergonomic handle.



Length 140 mm

0141

ELECTRICIAN SCISSORS



Length 5" 1/2 - 140 mm

F018

INSULATED ELECTRICIAN SCISSORS

1000V IEC 60900, with serrated blade, and ergonomic handle in ABS material.



Length 6" - 160 mm

0673

MULTIPURPOSE SCISSORS

With serrated blade, ergonomic bicolor non-slip plastic and rubber handle.



Length 175 mm / 7" mm

0325

MULTIPURPOSE SCISSORS

With serrated blade and ergonomic bicolor non-slip handle.



Length 210 mm / 8" mm

0424

PUNCH PLIER

It allows to perform small holes on materials of small thickness such as: paper, cardboard, rubber and leather



Length 250 mm

0081

HOLLOW PUNCH SET

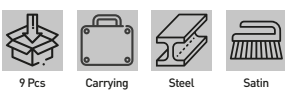

Sizes ø 5 - 6 - 8 - 10 - 12,5 - 16 - 20 - 25 - 32 mm

0093/22

PIPE CUTTER FOR COPPER AND PLASTIC

With zinc alloy body.

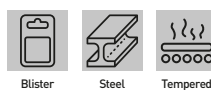

Cutting capacity 3÷22 mm , 1 / 8" ÷ 55 / 64"

0093/42
PIPE CUTTER FOR COPPER AND IRON

With aluminium alloy body.

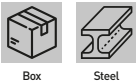

Cutting capacity	6÷42 mm , 15 / 64" ÷ 1-21 / 32"
Hardness	HRC 58-60

0472
PIPE FLARING TOOL FOR COPPER AND ALUMINUM

Round pipe	5 - 6 - 8 - 10 - 12 - 14 - 16 mm
------------	----------------------------------

0253
POLYURETHANE AND RUBBER HOSE CUTTER

Suitable for pe, pu and rubber hoses, bi-component handle.



Max Opening	19 mm
Length	133 mm

0846/150
RATCHET HAND CABLE CUTTER

For electric cables.

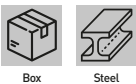

Cutting capacity	150 mm ² (Al - Cu)
Length	250 mm

0092
COPPER TUBE CUTTER

Capacity	3 ÷ 28 mm - 1/8" ÷ 1 1/8"
----------	---------------------------

0844
POLYURETHANE AND RUBBER HOSE CUTTER

Max cut	Ø 25 mm
---------	---------

0287-
BOLT CUTTER

Ideal for cutting iron rods, chains and a vast type of ferrous and non-ferrous materials.

Cr-V

Art.	Dimensions
0287/300	300 mm - 12"
0287/350	350 mm - 14"
0287/450	450 mm - 18"
0287/600	600 mm - 24"
0287/750	750 mm - 30"



0862

ADJUSTABLE AUTOMATIC WIRE STRIPPER



Blister



Steel

Max cut

Ø 0,8 ÷ 3,5 mm 0,25 ÷ 6 mm²

0513

CAMP AXE WITH FIBRE-GLASS HANDLE



Glass fiber

0101/500

CAMP AXE



Wood

0515

AXE WITH FIBRE-GLASS HANDLE



Glass fiber

Length

900 mm

0322

TELESCOPIC RATCHET LOPPING SHEARS TEFLON COATED HARDENED BLADE

Ergonomic handle.



Hangable



Steel



Tempered

Length

690 - 1030 mm



**0587-
STAPLES**

Art.	Model	Size
0587/8006	80	12,9 x 6h mm
0587/8008	80	12,9 x 8h mm
0587/8010	80	12,9 x 10h mm
0587/8012	80	12,9 x 12h mm
0587/8014	80	12,9 x 14h mm
0587/8016	80	12,9 x 16h mm

**0585-
STAPLES**

Art.	Model	Size
0585/9013	90	5,7 x 13h mm
0585/9019	90	5,7 x 19h mm
0585/9032	90	5,7 x 32h mm
0585/9040	90	5,7 x 40h mm

**0584-
NAILS**

Art.	Model	Size
0584/F10	TI-PIN	1 x 10h mm
0584/F15	TI-PIN	1 x 15h mm
0584/F20	TI-PIN	1 x 20h mm
0584/F25	TI-PIN	1 x 25h mm
0584/F30	TI-PIN	1 x 30h mm
0584/F35	TI-PIN	1 x 35h mm
0584/F40	TI-PIN	1 x 40h mm
0584/F45	TI-PIN	1 x 45h mm
0584/F50	TI-PIN	1 x 50h mm

**0588-
HEADLESS PINS**

Art.	Model	Size
0588/615	0,60	0,63 x 15h mm
0588/620	0,60	0,63 x 20h mm
0588/625	0,60	0,63 x 25h mm

**0151
STAPLES**

Stem	0,58 x 1,2 mm
------	---------------

**0295
RIVET SET**

25 Pcs 2.4x6.4 mm; 25 Pcs 2.4x8 mm; 25 Pcs 3.2x5 mm; 25 Pcs 3.2x6.4 mm; 25 Pcs 3.2x8 mm; 25 Pcs 4x6.4 mm; 25 Pcs 4x8 mm; 25 Pcs 4.8x6.4 mm; 25 Pcs 4.8x8 mm;

**0376/AC
CARBON STEEL NUT RIVET SET**

Yellow zinc plated, M3: 40 Pcs - M4: 40 Pcs - M5: 30 Pcs - M6: 20 Pcs - M8: 10 Pcs - M10: 5 Pcs - M12: 5 Pcs.



Nut rivets M3 - M4 - M5 - M6 - M8 - M10 - M12

**0376/AL****ALUMINUM NUT RIVET SET**

M4: 50 Pcs - M5: 35 Pcs - M6: 15 Pcs - M8: 10Pcs - M10: 10 Pcs.



120 Pcs



Hangable



Alu

Aluminum

Nut rivets

M4 - M5 - M6 - M8 - M10

0376/AI**STAINLESS STEEL NUT RIVET SET**

M3: 40 Pcs - M4: 40 Pcs - M5: 30 Pcs - M6: 20 Pcs - M8: 10Pcs - M10: 5 Pcs - M12: 5 Pcs.



150 Pcs



Hangable



INOX

Nut rivets

M3 - M4 - M5 - M6 - M8 - M10 - M12

0178**WASHER SET**

50 Pcs Grower #6; 50 Pcs Grower #8; 50 Pcs Grower #10; 40 Pcs Grower 1/4"; 30 Pcs Grower 5/16"; 20 Pcs Grower 3/8"; 50 Pcs Notched out. #6; 50 Pcs Notched out. #8; 50 Pcs Notched out. #10; 40 Pcs Notched out. 1/4"; 30 Pcs Notched out. 5/16"; 20 Pcs Notched out. 3/8"; 50 Pcs Notched ins. #6; 50 Pcs Notched ins. #8; 50 Pcs Notched ins. #10; 40 Pcs Notched ins. 1/4"; 30 Pcs Notched ins. 5/16"; 20 Pcs Notched ins. 3/8".



720 Pcs



Box



Alu

Aluminum

0229**COPPER WASHER SET**

30 Pcs M6; 25 Pcs M8; 20 Pcs M10; 15 Pcs M12; 10 Pcs M14; 10 Pcs M16.



110 Pcs



Box

0294**COTTER PIN SET**

150 Pcs 1/16" x 1"; 150 Pcs 3/32" x 1"; 100 Pcs 3/32" x 1 - 1/2"; 1/8" x 1-1/4"; 50 Pcs 1/8" x 2"; 30 Pcs 5/32" x 2-1/2".



555 Pcs



Box



Steel

0298**HITCH PIN SET**

42 Pcs 3/32"x1-3/16"; 30 Pcs 5/64"x1-5/16"; 25 Pcs 5/64"x1-9/16"; 25 Pcs 7/64"x1-5/18"; 20 Pcs 9/64"x1-3/4"; 8 Pcs 5/32"x2-15/16".



150 Pcs



Box



Steel

0231**ROLL PIN SET**

4 Pcs 4x16 mm; 4 Pcs 4x26 mm; 4 Pcs 4x40 mm; 4 Pcs 6x16 mm; 4 Pcs 6x32 mm; 4 Pcs 6x45 mm; 4 Pcs 8x20 mm; 4 Pcs 8x40 mm; 4 Pcs 8x50 mm; 4 Pcs 2x6 mm; 4 Pcs 2x14 mm; 4 Pcs 2x26 mm; 4 Pcs 1.5x5 mm; 4 Pcs 1.5x20 mm; 4 Pcs 1.5x8 mm; 4 Pcs 2.5x16 mm; 4 Pcs 2.5 x24 mm; 4 Pcs 2.5x32 mm; 5 Pcs 3x16 mm; 5 Pcs 3x26 mm; 5 Pcs 3x32 mm; 2 Pcs 10x20 mm; 2 Pcs 10x40 mm; 2 Pcs 10x50 mm; 4 Pcs 5.5x32 mm; 4 Pcs 5.5x45 mm; 4 Pcs 5.5x16 mm; 5 Pcs 5x16 mm; 5 Pcs 5x26 mm; 5 Pcs 5x32 mm.



120 Pcs



Box



Steel

0296**E-CLIP SET**

30 Pcs 1/16"; 30 Pcs 1/8"; 40 Pcs 3/16"; 50 Pcs 1/4"; 50 Pcs 3/8"; 40 Pcs 1/2"; 20 Pcs 5/8"; 20 Pcs 3/4"; 20 Pcs 7/8";



300 Pcs



Box



Steel

0179
SNAP RING SET

3 Pcs \varnothing 32; 5 Pcs \varnothing 25; 5 Pcs \varnothing 22; 10 Pcs \varnothing 16;
10 Pcs \varnothing 14; 10 Pcs \varnothing 10; 5 Pcs R14; 10 Pcs R12;
10 Pcs R10; 10 Pcs \varnothing 9; 10 Pcs \varnothing 8; 12 Pcs \varnothing 6.

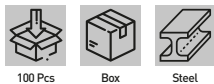
0257
PARALLEL KEY SET

5 Pcs 6x6x20 mm; 4 Pcs 3x3x20 mm; 4 Pcs
3x3x25 mm; 5 Pcs 8x5x32 mm; 5 Pcs 5x5x20
mm; 5 Pcs 8x7x36 mm; 5 Pcs 5x5x25 mm; 5
Pcs 10x8x40 mm; 5 Pcs 5x5x36 mm; 5 Pcs
10x8x50 mm; 5 Pcs 6x6x36 mm; 2 Pcs 12x8x40
mm; 5 Pcs 6x6x50 mm.

0116P
INCH CHROMED STEEL BALL SET

DIN 5401 grade, class III 50 Pcs 3/32"; 50 Pcs
1/8"; 50 Pcs 5/32"; 50 Pcs 3/16"; 50 Pcs 7/32";
50 Pcs 1/4"; 30 Pcs 9/32"; 30 Pcs 5/16"; 30 Pcs
11/32"; 20 Pcs 3/8"; 20 Pcs 13/32".



0299
METRIC O-RING SET

419 pieces in 32 different sizes made
of high quality NBR nitrile rubber, heat
resistant, oil resistant, gas resistant.

419 pieces in 32 different sizes made
of high quality NBR nitrile rubber, heat
resistant, oil resistant, gas resistant.

0263
WOODRUFF METRIC KEY SET

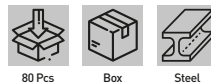
10 Pcs 4x7.5x19 mm; 10 Pcs 5x7.5x19 mm;
10 Pcs 3x5x13 mm; 10 Pcs 3x6.5x16 mm; 10
Pcs 4x5x13 mm; 10 Pcs 4x6.5x16 mm; 10 Pcs
5x9x22 mm; 10 Pcs 6x9x22 mm.

0116
METRIC CHROMED STEEL BALL SET

DIN 5401 grade, class III 50 Pcs 2.00 mm; 50
Pcs 2.50 mm; 50 Pcs 3.00 mm; 50 Pcs 3.50
mm; 50 Pcs 4.00 mm; 50 Pcs 4.50 mm; 50 Pcs
5.00 mm; 30 Pcs 5.50 mm; 30 Pcs 6.00 mm; 20
Pcs 7.00 mm; 20 Pcs 8.00 mm.

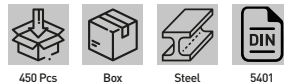
0180
SPRING SET

8 a Compress. 12 Ext. 10Pc Comp. 9/32"x 1/2";
10Pc Ext.13/64"x 13/16"; 10Pc Comp. 3/8"x
5/8"; 10Pc Ext.5/16"x 1-1/8"; 10Pc Comp.
1/4"x 13/32"; 10Pc Ext.7/32"x 1"; 10Pc Comp.
3/8"x 3/4"; 10Pc Comp. 7/32"x 11/16"; 10Pc
Ext.1/4"x 7/8"; 10Pc Ext.5/16"x 1-1/4"; 10Pc
Ext.11/32"x 1-27/32"; 10Pc Ext.5/16"x 1-3/4";
10Pc Ext.9/32"x 2"; 10Pc Ext.5/32"x 3-1/8";
10Pc Comp. 23/64"x 1-3/8"; 10Pc Ext.3/16"x
1-3/4"; 10Pc Comp. 7/32"x 1-1/2"; 10Pc
Ext.9/32"x 1-1/2"; 10Pc Comp 9/32"x 3/4";
10Pc Ext.11/32"x 1-7/16".

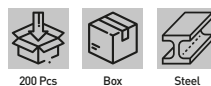

0299/P
O-RING SET IN INCHES

Assortment made of high quality NBR nitrile rubber, heat resistant, oil resistant, gas resistant.

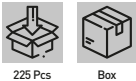

**0177****O-RING SET**

10 Pcs 3/32" x 15/64"; 20 Pcs 1/8" x 1/4"; 20 Pcs 5/32" x 9/32"; 20 Pcs 3/16" x 5/16"; 15 Pcs 7/32" x 11/32"; 15 Pcs 1/4" x 3/8"; 10 Pcs 9/16" x 3/4"; 10 Pcs 5/8" x 13/16"; 10 Pcs 11/16" x 7/8"; 10 Pcs 3/4" x 15/16"; 10 Pcs 3/4" x 1"; 10 Pcs 13/16" x 11/16"; 15 Pcs 5/16" x 7/16"; 10 Pcs 3/8" x 1/2"; 10 Pcs 5/8" x 3/4"; 10 Pcs 3/8" x 9/16"; 10 Pcs 7/16" x 5/8"; 10 Pcs 1/2" x 11/16".



225 Pcs

Box

0876**NYLON CABLE TIE SET**

650 Pcs

Box

300 Pcs	2,5 x 100 mm
200 Pcs	3,6 x 150 mm
150 Pcs	4,8 x 200 mm

0465**RUBBER GROMMET ASSORTMENT**

Grommets sizes: 5 Pcs - D 21 mm - ID 15 mm - OD 26 mm - T 2,2 mm 40 Pcs - D 9 mm - ID 6 mm - OD 13 mm - T 2,1 mm 5 Pcs - D 15 mm - ID 12 mm - OD 19 mm - T 1,9 mm 40 Pcs - D 5,8 mm - ID 2,5 mm - OD 7,9 mm - T 1,8 mm 40 Pcs - D 7,5 mm - ID 4,8 mm - OD 9,8 mm - T 1,8 mm 20 Pcs - D 12 mm - ID 10,5 mm - OD 15 mm - T 1,8 mm 25 Pcs - D 11 mm - ID 8,5 mm - OD 14,5 mm - T 1,5 mm 5 Pcs - D 25 mm - ID 18 mm - OD 32 mm - T 1,5 mm.



180 Pcs

Box

0307/1**GLASS FUSE SET**

Fast: 10 x 1A F1, 10 x 1.25A F1, 10 x 1.6A F1, 10 x 2A F1, 10 x 2.5A F1, 10 x 4A F1, 10 x 5A F1, 10 x 6.3A F1, 10 x 10A F1, time delay: 10 x 1A F1 T, 10 x 1.25A F1 T, 10 x 1.6A F1 T, 10 x 2A F1 T, 10 x 2.5A F1 T, 10 x 4A F1 T, 10 x 5A F1 T, 10 x 6.3A F1 T, 10 x 10A F1 T.



180 Pcs

Hangable

Dimensions	5 x 20 mm
------------	-----------

0261**HOSE CLIP SET**

2 Pcs 12.8x0.9x50-70 mm; 4 Pcs 12.8x0.9x35-50 mm; 8 Pcs 12.8x0.9x25-40 mm; 6 Pcs 10x0.8x12-22 mm.

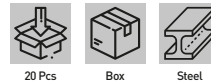

20 Pcs

Box

Steel

Dimensions	10 x 0,8 x 12-22 mm ; 12,8 x 0,9 x 25-40 mm ; 12,8 x 0,9 x 35-50 mm ; 12,8 x 0,9 x 50-70 mm
------------	---

0398**SCREW AND U TYPE CUSHIONS ASSORTMENT**

Screws: 3x8 mm 40Pcs 4x16 mm 20Pcs 5x12 mm 15Pcs 6x20 mm 10Pcs U clips: 3 mm 20Pcs 4 mm with notch 20Pcs 4 mm 20Pcs 5 mm 15Pcs 6 mm 10Pcs.

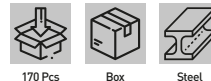

170 Pcs

Box

Steel

0468**CONNECTING PLATE AND SCREW ASSORTMENT**

4 Pcs Assembly square: 25x25x16x2.0 mm 8 Pcs Assembly square: 40x40x16x2.0 mm 4 Pcs Assembly square: 60x60x16x2.0 mm 4 Pcs L Assembly square: 75x75x16x2.0 mm 4 Pcs L Flat angle plate: 40x40x12x2.0 mm 4 Pcs L Flat angle: 60x60x12x2.0 mm 4 Pcs Flat plate Connector: 80x15x2.0 mm 4 Pcs Flat plate Connector: 40x15x2.0 mm 144 Pcs screws: 3x16 mm.

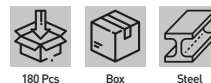

180 Pcs

Box

Steel

0307/2**GLASS FUSE SET**

Time delay: 10 Pcs 100mA T, 10 Pcs 160mA T, 10 Pcs 200mA T, 10 Pcs 250mA T, 10 Pcs 315mA T, 10 Pcs 400mA T, 10 Pcs 500mA T, 10 Pcs 630mA T, 10 Pcs 800mA T, fast: 10 Pcs 100mA F, 10 Pcs 160mA F, 10 Pcs 200mA F, 10 Pcs 250mA F, 10 Pcs 315mA F, 10 Pcs 400mA F, 10 Pcs 500mA F, 10 Pcs 630mA F, 10 Pcs 800mA F.



180 Pcs

Hangable

Dimensions	5 x 20 mm
------------	-----------

0317

CAR FUSE SET

3A 15 Pcs, 5A 15 Pcs, 7.5A 15 Pcs, 10A 15 Pcs, 15A 15 Pcs, 20A 15 Pcs, 25A 15 Pcs, 30A 15 Pcs, Fuse puller 1 Pc.



Dimensions 19.1 x 5.1 x 18.5 mm

0318

CAR FUSE SET

2 AMP x 10 pz; 3 AMP x 10 pz; 4 AMP x 10 pz; 5 AMP x 10 pz; 7.5 AMP x 20 pz; 10 AMP x 10 pz; 15 AMP x 20 pz; 20 AMP x 20 pz; 25 AMP x 20 pz; 30 AMP x 10 pz; Fuse Puller x 1

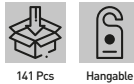

Dimensions 10.9 x 3.6 x 16.3 mm

0293

INSULATED TERMINAL SET

15 Pcs FDD1-110 2.8x0.5/0.8 mm; 15 Pcs FDD1-187 4.75x0.5/0.8 mm; 10 Pcs FDD2-187 6.35x0.5/0.8 mm; 15 Pcs FDD1-250 4.75x0.5/0.8 mm; 10 Pcs FDD2-250 6.35x0.8 mm; 10 Pcs FDD5-250 6.35x0.8 mm; 10 Pcs BV1; 10 Pcs BV2; 10 Pz BV5; 10 Pcs MDD1-250; 10 Pcs MDD2-250; 10 Pcs MDD5-250; 10 Pcs SVL1.25-3.7; 10 Pcs SVL1.25-4; 10 Pcs SVL1.25-5.3; 10 Pcs SVM2-4; 10Pcs SVS2-5; 10 Pcs SVL5-4; 10 Pcs SVL5.5-4.



0380

PVC SHRINKABLE TUBE ASSORTMENT

30 Pcs 5/64"x1-9/16"; 25 Pcs 3/32"x1-9/16"; 20 Pcs 1/8"x1-9/16"; 30 Pcs 3/16"x1-9/16"; 16 Pcs 9/32"x3-1/8"; 8 Pcs 3/8"x3-1/8"; 8 Pcs 1/2"x3-3/8".



0877

END TERMINAL SET

50 Pcs 0.5 mm²; 100 Pcs 0.75 mm²; 100 Pcs 1.0 mm²; 100 Pcs 1.5 mm²; 50 Pcs 2.5 mm².

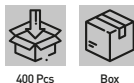

White end	50 x 0,5 mm ²
Grey end	100 x 0,75 mm ²
Red end	100 x 1 mm ²
Black end	100 x 1,5 mm ²
Blue end	50 x 2,5 mm ²

0176

GREASE FITTING SET

Pcs. 35 straight M6x1; Pcs. 15 Straight 1/8"-27; Pcs. 5 45° 1/8"-27; Pcs. 5 45° M6x1; Pcs. 10 45° M8x1; Pcs. 5 45° M10x1; Pcs. 10 Straight M10x1; Pcs. 10 Straight M8x1; Pcs. 5 90° M6x1; Pcs. 5 90° M8x1; Pcs. 5 90° M10x1.

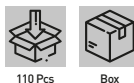

SR44W

BATTERIES FOR DIGITAL INSTRUMENTS



Voltage	1,5 V
Pack	10



CR20X

BATTERIES FOR DIGITAL INSTRUMENTS

Art.	Voltage	Pack
CR2025	3 V	10
CR2032	3 V	10





0678

POLYURETHANE FOAM GUN

Mount and foam adjustment.



Box

Length 290 mm

0085

9" HEAVY DUTY CAULKING GUN



Nickel plated



0521

9" HEAVY DUTY CAULKING GUN



Nickel plated



0234

9" REINFORCED CAULKING GUN SKELETON TYPE EXAGONAL ROD



Steel



0091

9" RATCHET CAULKING GUN BARREL TYPE



0604

9" EPOXY SEAL CAULKING GUN 345 ML AND 235 ML



Nickel plated



0861

9" EPOXY SEAL CAUL KING GUN



Nickel plated

0820-

SQUARE TROWELS



Steel



Art.	Length
0820/18	180 mm
0820/20	200 mm

0822

PLASTERING TROWEL WITH ABS HANDLE



Steel



Length	280 x 120 mm
--------	--------------

0184-

PUTTY KNIFE WITH CLIPPED PLASTIC HANDLE MIRROR POLISH



INOX

Art.	Blade dimensions
0184/01	30 x 90h mm
0184/02	50 x 95h mm
0184/03	75 x 100h mm
0184/04	100 x 100h mm

0819-

BRICKLAYING TROWELS ROUND NOSE



Steel



Art.	Length
0819/18	180 mm
0819/20	200 mm

0821/14

BRICKLAYING TROWEL ROUND NOSE



Steel



Length	140 mm
--------	--------

0823

NOTCHED TROWEL WITH ABS HANDLE



Steel



Length	280 x 120 mm
--------	--------------

0606

POLYETHYLENE BUCKET



Dimensions	ø 360 x 240h mm
Capacity	14 l



0043

RED AND WHITE SIGNAL TAPE



Length	200 m
Height	70 mm

0747

PPL TAPE HAVANA COLOR



Belt dimensions	50 mm x 66 m
Pack	6

PVC300/125

PPL FILM



Dimensions	0,125h x 100 m
Thickness	20 µm
Pack	48

PVC300

PPL FILM



Dimensions	0,5h x 300 m
Thickness	23 µm
Pack	6

0103

TAPE FILM DISPENSER



Box

0760

STRETCH FILM HANDLE DISPENSER



0748

PPL FILM HANDLE DISPENSERS

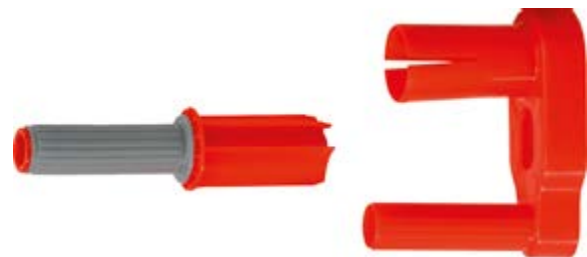

028X

POLYETHYLENE PROTECTION COVER SHEET, TWO-COLOUR GRAY - BLUE

Protected to uv rays, woven polyethylene tarpaulin 140/150 g/m², eyelets every 50cm.



Art.	Dimensions	Net weight
0281	2,86 x 1,90 m	0,9 kg
0282	4 x 5 m	2,8 kg
0283	5 x 8 m	5,6 kg
0284	6 x 10 m	8 kg